

Logan

LATHES

SHAPERS • ACCESSORIES



Sterling
MACHINERY EXCHANGE

LOGAN ENGINEERING CO.

4901 W. Sterling Machinery.com 30, ILL.



N A M E P L A T E

T H E R A N G E O F L O G A N

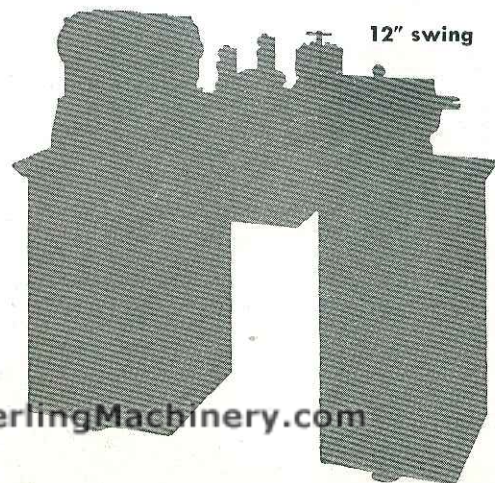
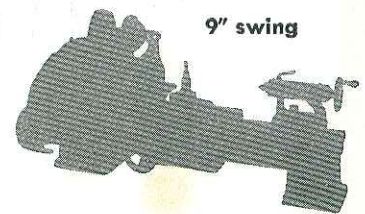
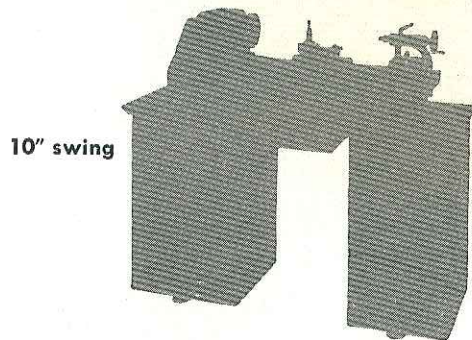

Sterling
MACHINERY EXCHANGE

www.SterlingMachinery.com

OF DEPENDABILITY

Experience through many years has *proved* the dependability of Logan Lathes and Shapers. Successful experience. Production maintained. Tolerances held. Operating costs reduced to minimum. That has been the pattern of Logan performance year after year. As a result, the Logan name plate has gained world-wide recognition as a stamp of dependability.

The Logan tradition of dependability continues as today's Logan Lathes and Shapers take over an ever increasing number of jobs. Logan advanced design continues a step ahead. The ruggedness of Logan construction is more evident than ever. Thorough testing and dynamic balancing of every completed lathe make accuracy certain before shipment is made. Your shop, your production line can gain new efficiency through the sustained accuracy, the power, the speed and the truly dependable performance these Logan machines deliver.

LATHES AND SHAPERS

LATHES

Logan Lathes are available in screw-cutting and turret models. Sizes range from the 9" and 10" swing models with $\frac{1}{2}$ " draw-in collet capacity and $\frac{25}{32}$ " bore to the 11", 12" and 14" swing lathes with 1" collet capacity and $1\frac{3}{8}$ " spindle bore. Cabinet, Pedestal Base, Leg and Pan, and Bench models. V-belt Drives and Variable Speed Drives. Cabinet models have convenient built-in tool storage compartments.

SHAPERS

Powerful $8\frac{1}{2}$ " maximum stroke permits full and accurate machining of work 8" long. Six automatic feeds in either direction, from .002" to .012". 8"x8" table has a vertical travel of $5\frac{1}{2}$ " and a $10\frac{1}{2}$ " traverse.

ACCESSORIES

A complete line of attachments and accessory equipment greatly increases the versatility of Logan Lathes and Shapers.

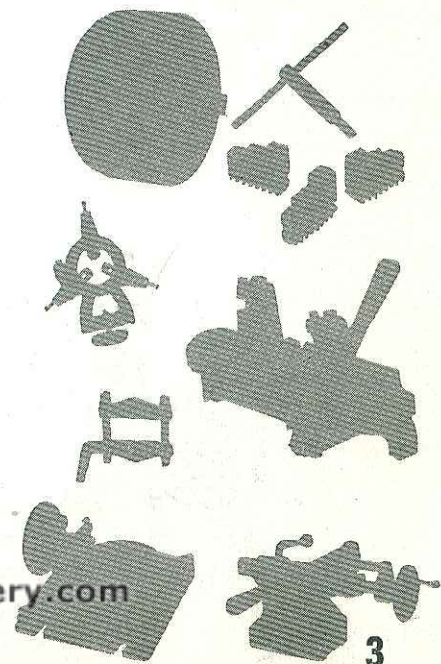
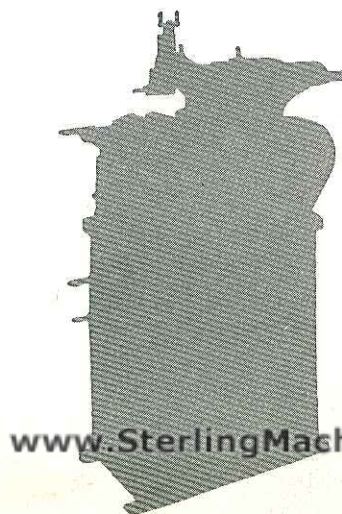

ADVANCED DESIGN . . . RUGGED CONSTRUCTION . . .

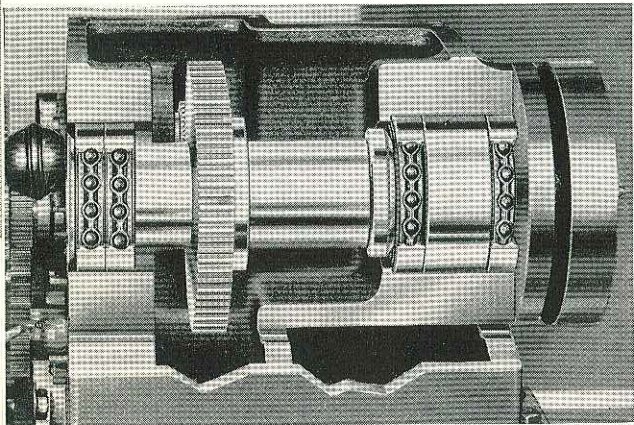

BALL BEARING HEADSTOCK and SPINDLE

The headstock on every Logan Lathe is designed, built and balanced for rigidity, and for smooth power, free from noise or vibration. The Logan 12" lathe headstock illustrated shows the massive proportions of the Logan spindle with $1\frac{3}{8}$ " bore, and the ball bearing mounting that needs no adjustment for any standard rpm. Logan 9", 10" and 11" lathes also have ball bearing spindles that assure sustained accuracy and permit using high speed carbide tipped cutting tools to fullest advantage. Logan 14" Lathes have a headstock and spindle of the same basic design as that shown, but of heavier and more powerful construction.

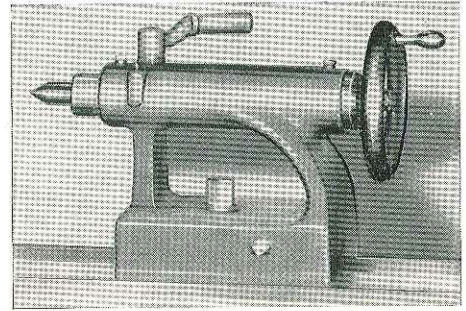

RIGIDLY CONSTRUCTED TAILSTOCK

Tailstocks on all Logan Lathes are easy to handle and provide rigid support of the work. The 14" lathe tailstock shown typifies Logan construction. It is bored for a No. 3 Morse taper. The spindle travel is $5\frac{1}{2}$ " in graduations of $\frac{1}{16}$ ". Set-over for taper turning is $\frac{9}{16}$ ".

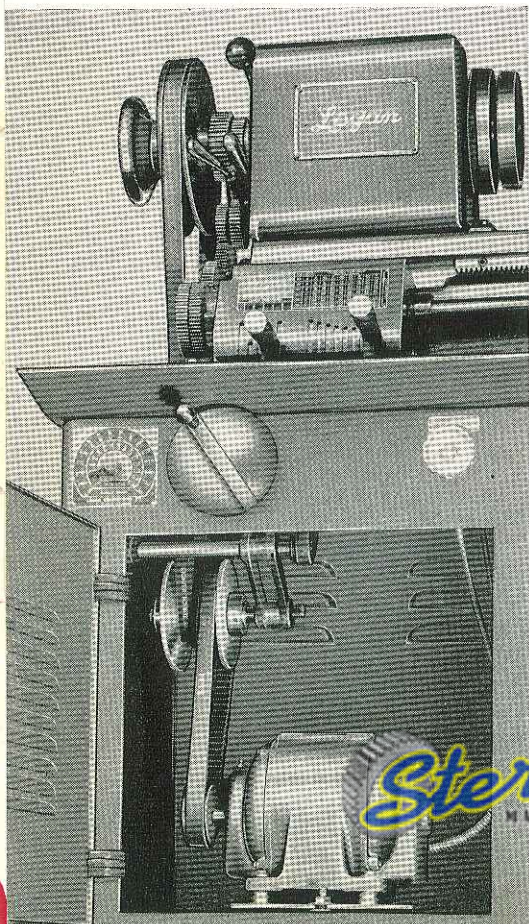

VARIABLE SPEED DRIVE

Simply adjust the Speed Control Handle *while the lathe is running* to obtain any desired rpm within the speed range of a Logan Variable Speed drive lathe. There is no stopping of the lathe, no shifting of belts. The speed control handle is synchronized with an easily readable rpm indicator which gives instant visual indication of spindle speed. Motor and drive assembly are enclosed and easily accessible in the lower left compartment of the cabinet base. On the Logan 14" Lathe, infinite speeds from 38 to 180 rpm and from 240 to 1200 rpm are available. On 12" lathes, the infinite speed range is from 38 to 1400 rpm.

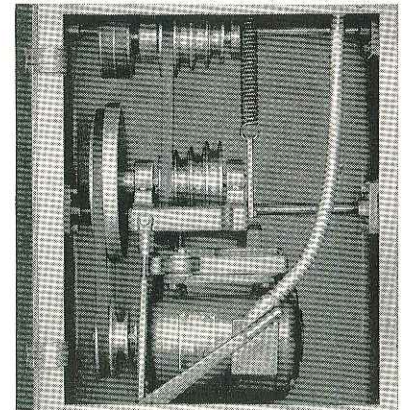

BALL BEARING UNDERNEATH V-BELT DRIVE

The motor drive assembly of Logan Cabinet base lathes is completely self contained and is enclosed in the compartment below the headstock. The jackshaft and countershaft turn on ball bearing mountings. Belt tension is released by simply adjusting the lever on the right side of the compartment. Motor and all drive parts are easily accessible.

... SUSTAINED ACCURACY

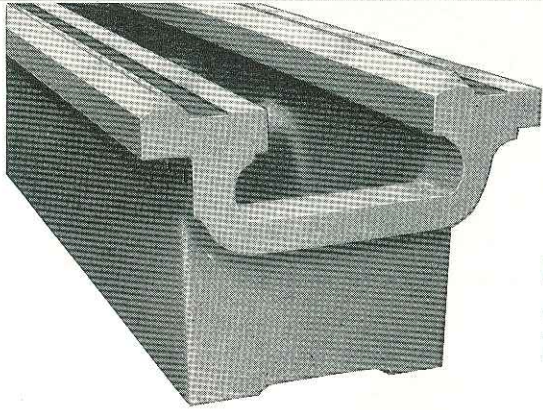

**RUGGED,
ACCURATE
BED**

The Logan 14" lathe bed illustrated here is 68" long and 10" wide, with high, strong walls braced by over-size ribs. Like all Logan lathe beds, it withstands the heaviest bending and torsional stresses. Balanced sections of even thickness neutralize internal stresses. Special alloy construction, and thorough seasoning before and between machining operations make the Logan bed warp-free. The two V-ways and two flat ways on every Logan Lathe bed are precision ground. Flame hardened beds are available on small 10", 11", 12" and 14" lathes at only small extra cost. See price list.

PRECISION CARRIAGE

The carriage of every Logan Lathe is built for rigidity, accuracy and convenience. With its double-walled apron, lever-operated disc type clutch, and large, legible dials the 14" lathe carriage shown is typical of Logan carriages. It has large, precision ground surfaces on cross slide and saddle for gauges and indicators. Wide, long cross slide accommodates a taper attachment. Large tool post and heavy compound add to rigidity. Longitudinal and cross feeds operate from spline in lead screw through worm drive and friction clutch. Additional half-nut drive from lead screw for thread cutting. Automatic lock prevents either feed from operating while the other is engaged. Gears run in oil bath.

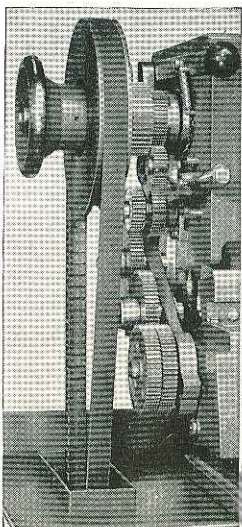
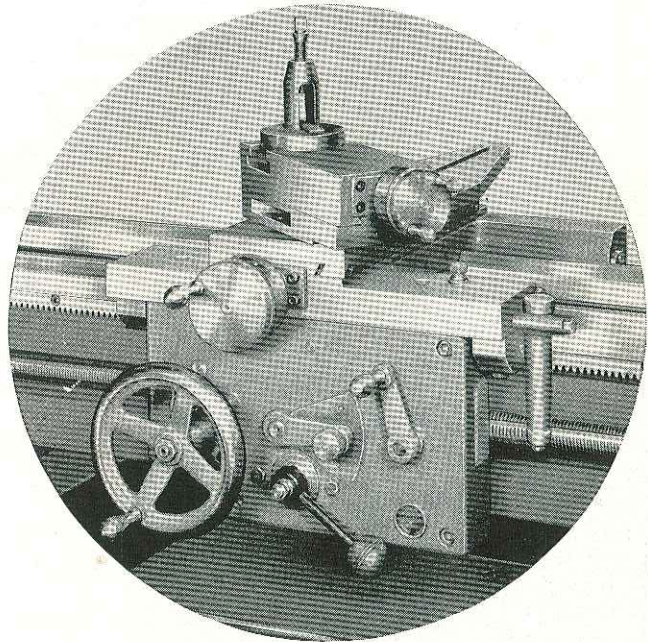

QUIET GEARS

Wide, rugged, machine-cut gears are characteristic of all Logan Lathes. Shown are the quiet-running gears of the Logan 14" lathe. The special "Ductile Iron" change gears of this lathe have as much as triple the strength of cast iron gears and tensile strength superior to most steel gears. Conveniently arranged

CONVENIENT STORAGE

Storage space for work and tools is provided in two ways in Logan Cabinet Base Lathes by:

3 compartments inside the right pedestal (as illustrated).

3 pull-out drawers in the right pedestal.

The drop center pan, with extra chip capacity is another feature of solid, strong Logan

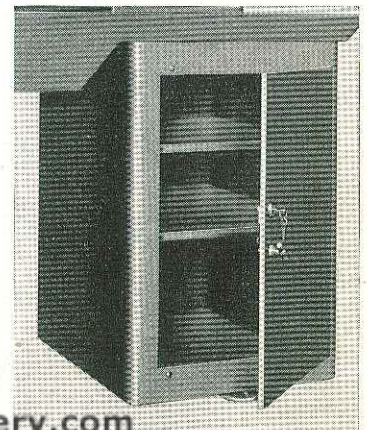

www.SterlingMachinery.com

THE *Logan* No. 6560

14" SWING LATHE

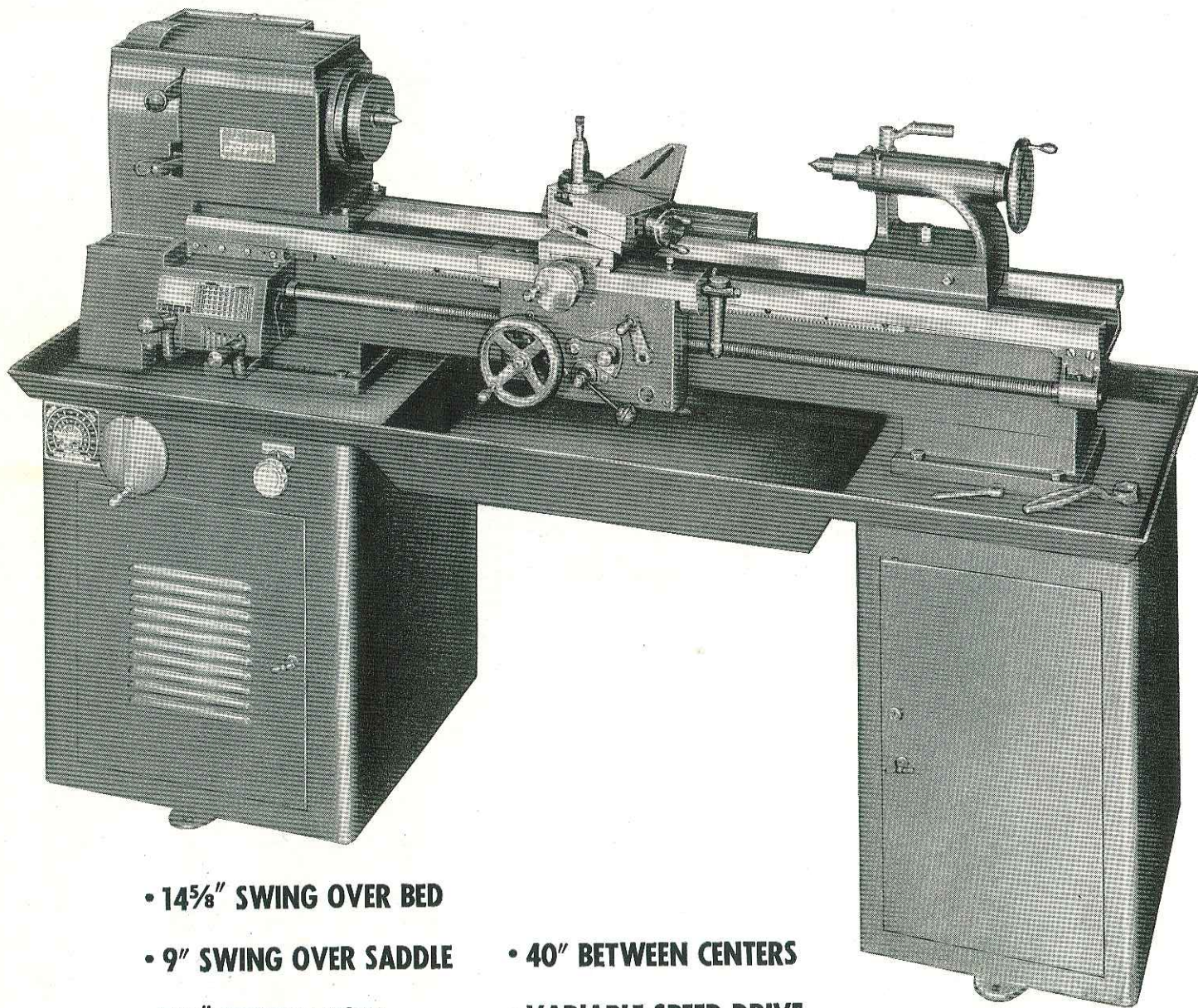

- 14 $\frac{5}{8}$ " SWING OVER BED
- 9" SWING OVER SADDLE
- 1 $\frac{3}{8}$ " SPINDLE HOLE
- 1" COLLET CAPACITY
- BALL BEARING SPINDLE 38 TO 1200 RPM
- TWO WAY TWO WAY, PRECISION GROUND BED
FURNISHED FLAME HARDENED AT SMALL EXTRA COST
- 40" BETWEEN CENTERS
- VARIABLE SPEED DRIVE
- PRECISION CARRIAGE

Spending

www.sterlingmachinery.com

RESULTS PROVE ITS SUPERIOR PERFORMANCE...

Just seeing this big, rugged lathe in action provides convincing proof of its superiority. It takes the heaviest cuts with almost no perceptible vibration. Turning work at maximum speed, it runs smoothly, quietly, with precision results.

Smooth-running power is built into the 6560. There is extra strength in the wide gears, heavy bearing supports, massive headstock, carriage and base. This extra weight plus dynamic balancing of the completed lathe reduces vibration to an absolute minimum. Many more advanced design and construction features like those illustrated on pages 4 and 5 are additional reasons for the superior performance this 14" Logan Lathe delivers.

The Variable Speed Drive provides instant rpm adjustment on work requiring a variation of spindle speed. The oversize spindle, with 1 3/8" bore, turns on precision ball bearings that need no adjustment within the full range of 38 to 1200 rpm.

The massive, precision ground bed is furnished with its two V-ways and two flat ways *flame hardened* at only small additional cost.

An L-00 Taper Spindle Nose is also furnished on the 6560 at extra charge when specified in your order.

Here, in brief, are Logan sustained accuracy and dependability combined with the greater capacity and smoother power of big lathe proportions.



www.SterlingMachinery.com

SPECIFICATIONS

CAPACITY OF LATHE

Swing over bed.....14 5/8"
Swing over saddle cross slide.....9"
Center distance.....40"

THREADS AND FEEDS

Quick change gear box and automatic apron.
Worm drive from lead screw spline for power feeds.
Longitudinal feed .0018" to .1000" per spindle revolution.
Crossfeed .20 times longitudinal feed.
Half nut drive from lead screw thread for thread cutting.
Threads, 48 selections R.H. or L.H. — 4 to 224 per inch.
Lead screw diameter and threads per inch — 1 1/8"-8.

HEADSTOCK AND SPINDLE

Spindle bearings: (4) sealed and shielded precision ball bearings.
Hardened and ground steel spindle.
Hole through spindle — 1 3/8".
Spindle nose diameter and threads per inch — 2 1/4"-8.
Drive plate diameter — 6".
Variable speed drive — Spindle speeds:
Direct Drive — 240 to 1200 rpm; with Back Gears Engaged — 38 to 186 rpm.
Spindle nose adapter to #3 Morse.

CROSS SLIDE AND COMPOUND REST

Cross slide travel.....10"
Compound rest travel.....4"
Compound rest graduated 90° in both directions.
Tool post opening for 1/2" x 1 1/8" tool holder.

BED

Width of bed across ways.....10"
Length of bed.....68"
Precision ground ways, two prismatic V-Ways and two flat ways.

TAILSTOCK

Spindle travel.....5 1/2"
Spindle graduation.....1/16"
Morse taper center.....#3
Tailstock set-over for taper turning 9/16"

UNDERNEATH DRIVE

Variable speed.

MOTOR AND SWITCH

Use 2 H.P., 3 phase motor, 1750 R.P.M.
Drum type reversing switch furnished.

EQUIPMENT INCLUDED WITH LATHE

1 — Drive Plate { 7 1/2" for 2 1/4" — 8 spindle
7" for L-00 spindle
2 — No. 3 M.T. 60° centers.
1 — Threading dial. 1 — Threading chart.
1 — Tool post and wrench. 1 — Motor pulley.
1 — Drum reversing switch.
1 — Spindle adapter sleeve to No. 3 M.T.
1 — Tailstock Wrench
Necessary Belts

OVERALL DIMENSIONS

83" long, 27" wide, 51" high.
No. 6560 LOGAN 14" Lathe, with No. 1122 Motor installed. Ship. Wt.: 1850 lbs.

Important

To obtain maximum performance from the Logan 14" Lathe either purchase No. 1122 2 HP, 3 phase motor with the lathe or send us your own motor for installation on a cost basis in the lathe so that we can dynamically balance the complete unit. Otherwise we cannot be responsible for vibration in your lathe. To insure maximum efficiency and reserve power always use 2 HP, 3 phase motor.

S
P
R
E
C
I
F
I
C
A
T
I
O
N
S

Logan 12" SWING LATHES

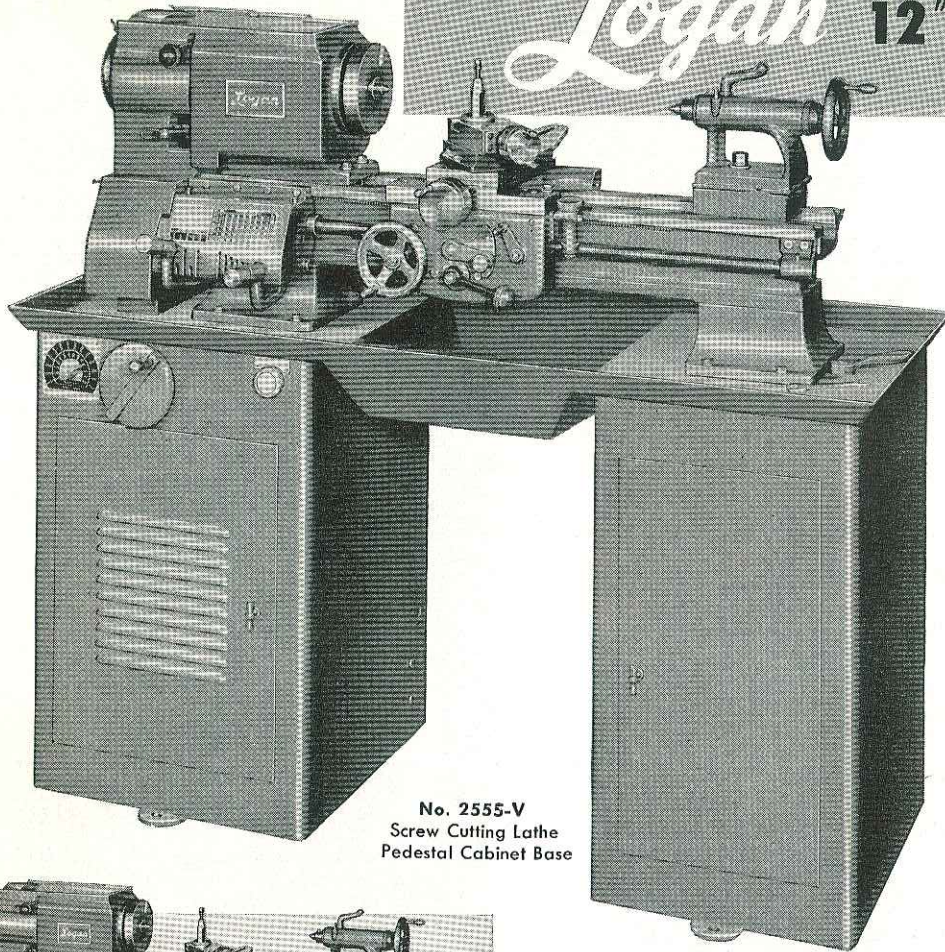

No. 2555-V
Screw Cutting Lathe
Pedestal Cabinet Base

- 1" COLLET CAPACITY
- 1 3/8" SPINDLE BORE
- 23" and 35" CENTERS
- VARIABLE SPEED DRIVE
- FLAME HARDENED BED
AT SMALL EXTRA COST

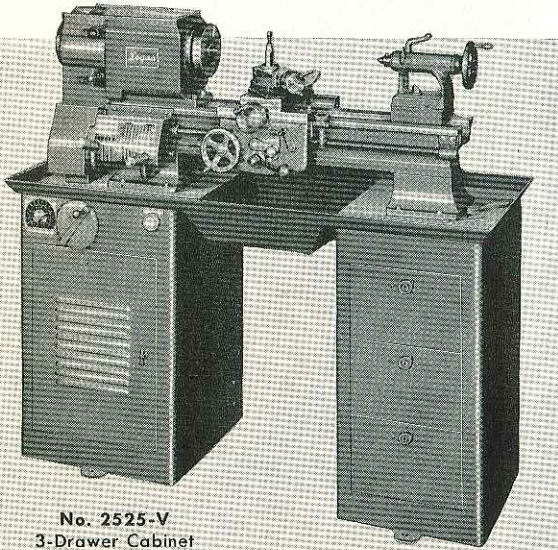

No. 2525-V
3-Drawer Cabinet
Screw Cutting Lathe.

Accuracy and smooth power are designed and built into these rugged, balanced lathes. Gears are extra wide and strong. Shafts are extra heavy. Lead screws have a full 7/8" diameter. The precision carriage rides on a two-V-way, two-flat-way bed that is rugged, precision-ground and warp-free. The heavy special alloy spindle turns on four oversize ball bearings, and needs no bearing adjustment for any speed within its wide rpm range. This advanced design plus precise, extra heavy construction and dynamic balancing of every completed lathe combine to assure sustained accuracy and smooth, quiet operation.

Compact all steel cabinet bases provide a clean-cut appearance and save floor space. Three compartments or three drawers inside each cabinet store and protect tools and work.

The Variable Speed Drive provides instant rpm adjustment on work requiring variation of spindle speed.

At only small extra cost, the bed is furnished flame hardened. The L-00 Spindle Nose also available at extra cost.

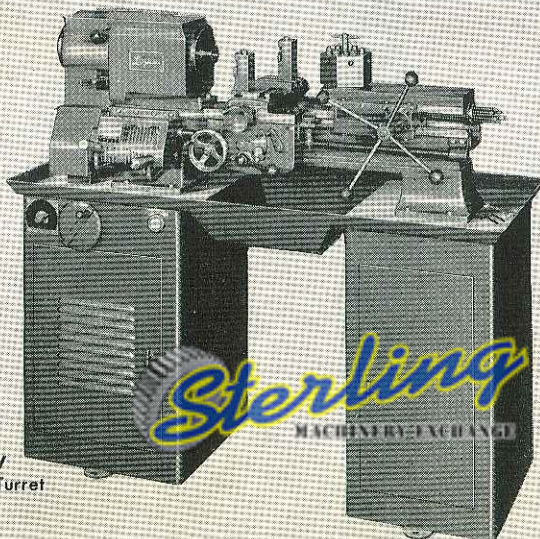

No. 2535-2-V
Pedestal Cabinet Turret
Lathe.

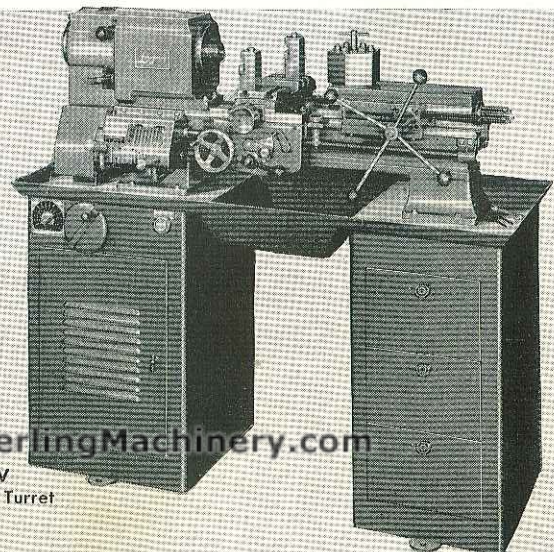

No. 2545-2-V
3-Drawer Cabinet Turret
Lathe.

Sterling
MACHINERY, FACTORY

www.SterlingMachinery.com

CAPACITY OF LATHE

Swing over bed.....12"
 Swing over saddle cross slide.....7 1/4"
 Center Distance.....23" (2555).....35" (2557)

THREADS AND FEEDS

Quick Change Gear Box and Automatic Apron
 Worm Drive from lead screw spline for Power feeds
 Longitudinal feed .0018" to .1000" per spindle revolution
 Cross feed .25 times longitudinal feed
 Half nut drive from lead screw thread for thread cutting
 Threads 48 selections RH or LH -4 to 224 per inch
 Lead screw diameter and threads per inch - 1/8"-8

HEADSTOCK AND SPINDLE

Spindle Bearings: (4) Sealed, Precision Ball Bearings
 Hardened and ground 52-100 steel spindle
 Hole through Spindle: 1 3/8"
 Draw-in Collet Capacity, 1"
 Spindle Nose diameter and threads per inch: 2 1/4"-8
 Drive Plate Diameter: 6"
 Spindle Nose Adapter to #2 Morse
 Variable Speed Drive - Infinite spindle speeds - 38 to 1400 rpm

CROSS SLIDE AND COMPOUND REST, SCREW CUTTING LATHE

Cross Slide Travel: 6 1/4"
 Compound Rest Travel: 2 1/4"
 Compound Rest graduated 90° in both directions
 Tool Post Opening for Tool Holder: 3/8" x 3/4"

CROSS SLIDE, TURRET LATHE

Cross slide travel: 6 5/8"
 Cross slide graduated in thousandths
 Cross feed screw mounted on self lubricating bronze bearings
 Adjustable double tool post with adjustable wedges
 Tool post openings: 1/16" x 1 1/16"

BED

Width of bed across ways: 61 5/16"
 Length of bed (2555).....43 1/8" (2557).....55 1/8"
 Precision ground ways, 2 prismatic "V" ways and 2 flat ways

TAILSTOCK

Spindle Travel.....4"
 Spindle Graduations.....1/16"
 Morse Taper Center.....#2
 Tailstock set-over for Taper turning.....11/16"

TURRET

Distance across flats: 5 1/4"
 Six position, self indexing with adjustable stops
 Turret holes, diameter 5/8" regular - 3/4" on special order
 Turret holes bored from headstock of lathe
 Maximum stroke of turret - Pilot Wheel
 Model: 7 3/4" ... Lever Type: 4 1/4"

UNDERNEATH DRIVE

Variable Speed.

MOTOR AND SWITCH

Use 1 HP, 3-Phase motor 1750 rpm
 Drum type reversing switch furnished

EQUIPMENT INCLUDED WITH SCREW CUTTING LATHE

- 1 - Drive Plate { 6" for 2 1/4" - 8 spindle
 { 7" for L-00 spindle
- 2 60° Centers
- 1 Threading Dial
- 1 Threading Chart
- 1 #2 Morse Taper Adapter Sleeve
- 1 Tool Post and Wrench
- 1 Tailstock Wrench
- 1 Drum Reversing Switch
- 1 Motor Pulley
- Necessary Belts
- Parts List and Instruction Book

DIMENSIONS

Centers	Bed Length	Overall Length	Width	Height
23"	43"	59"	22"	49"
or	or	or	for all	for all
35"	55"	70 1/2"	lathes	lathes

SCREW CUTTING LATHES

Lathe No.	Description	Ship Wt. (lbs.)
2525-V	Quick Change, 3-Drawer Cabinet Model, 23" Centers, Variable Speed Drive	1040
2527-V	Quick Change, 3-Drawer Cabinet Model, 35" Centers, Variable Speed Drive	1090
2555-V	Quick Change, Pedestal Cabinet Model, 23" Centers, Variable Speed Drive	1015
2557-V	Quick Change, Pedestal Cabinet Model, 35" Centers, Variable Speed Drive	1075

TURRET LATHES

2535-V	Quick Change, Pedestal Cabinet Model, 43" Bed, Lever Turret, Variable Speed Drive	1170
2535-2-V	Quick Change, Pedestal Cabinet Model, 43" Bed, Pilot Wheel Turret, Variable Speed Drive	1180
2537-V	Quick Change, Pedestal Cabinet Model, 55" Bed, Lever Turret, Variable Speed Drive	1230
2537-2-V	Quick Change, Pedestal Cabinet Model, 55" Bed, Pilot Wheel Turret, Variable Speed Drive	1240
2545-V	Quick Change, 3-Drawer Cabinet Model, 43" Bed, Lever Turret, Variable Speed Drive	1190
2545-2-V	Quick Change, 3-Drawer Cabinet Model, 43" Bed, Pilot Wheel Turret, Variable Speed Drive	1200
2547-V	Quick Change, 3-Drawer Cabinet Model, 55" Bed, Lever Turret, Variable Speed Drive	1240
2547-2-V	Quick Change, 3-Drawer Cabinet Model, 55" Bed, Pilot Wheel Turret, Variable Speed Drive	1250

IMPORTANT

To obtain maximum performance from the Logan 12" Lathe either purchase No. 1120 1 HP, 3 phase motor with the lathe or send us your own motor for installation on a cost basis in the lathe so that we can dynamically balance the complete unit. Otherwise we cannot be responsible for vibration in your lathe. To insure maximum efficiency and reserve power always use 1 HP, 3 phase motors.

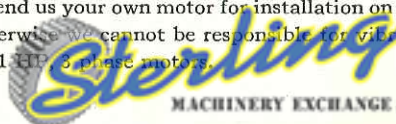

Logan 11"

SWING LATHES

- 1" COLLET CAPACITY
- 1 $\frac{3}{8}$ " SPINDLE BORE
- 24" and 36" CENTERS
- 16-SPEED V-BELT DRIVE

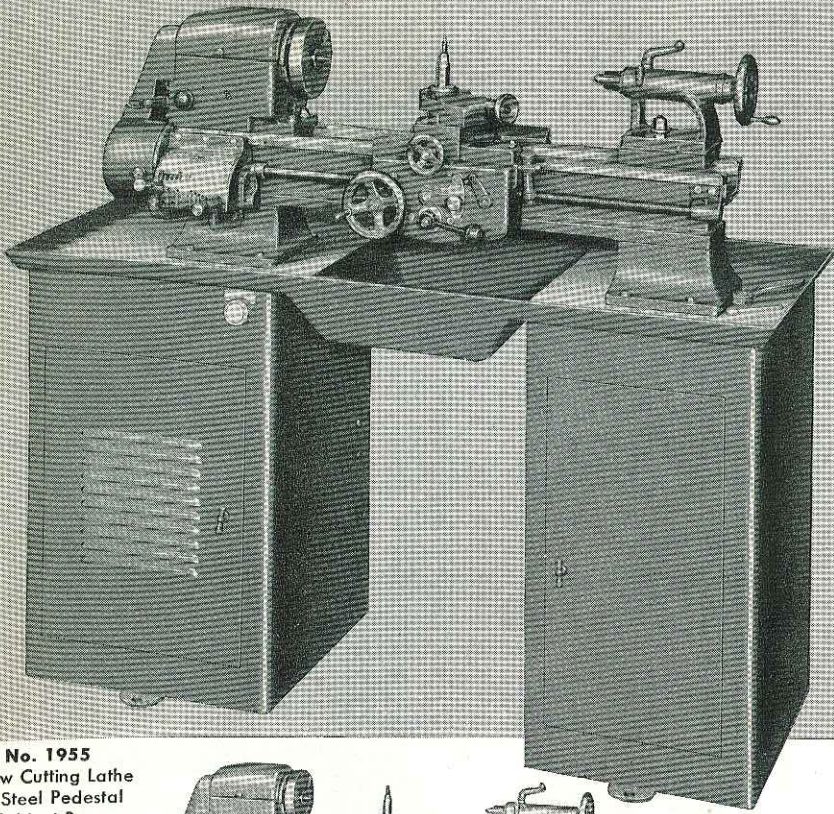

No. 1955
Screw Cutting Lathe
on Steel Pedestal
Cabinet Base

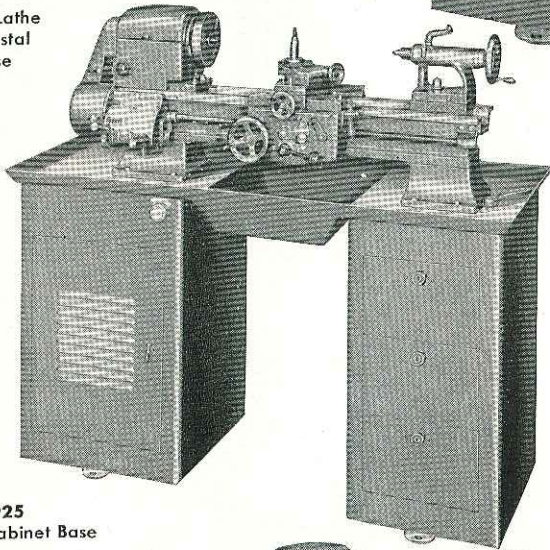

No. 1925
on 3-Drawer Cabinet Base

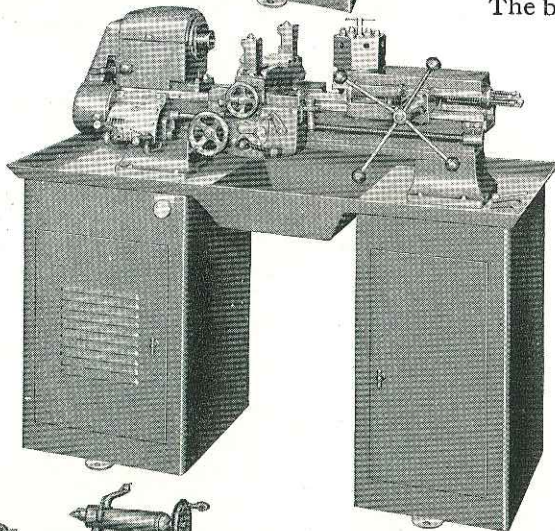

No. 1935-2
on Pedestal Cabinet Base

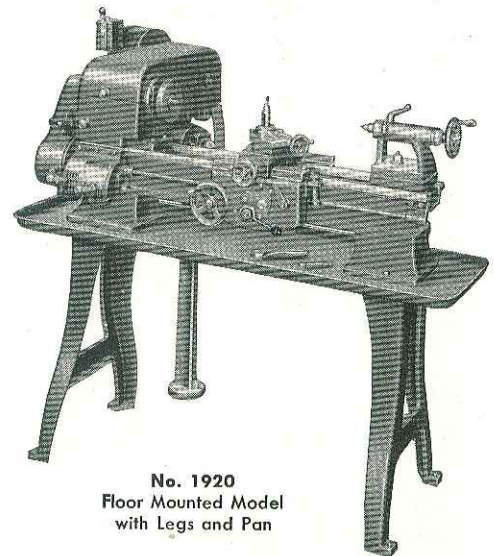

No. 1920
Floor Mounted Model
with Legs and Pan

These 11" swing Logans have the ruggedness and sustained accuracy to fill a definite need in both industrial and school shops. The advanced design features include a ball bearing spindle that needs no adjustment for any speed within its wide range. The Automatic Apron with lever-operated, disc type clutch moves over a rugged bed with its two V-ways and two flat ways precision ground. Ruggedly proportioned as well as precision built, these balanced 11" Logans are accurate when you set them up and still accurate after years of use. All cabinet models have three enclosed compartments or drawers for convenient tool and work storage. The bed is furnished flame hardened at small extra cost.

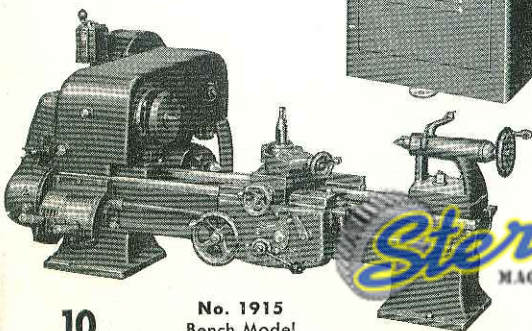

No. 1915
Bench Model

Sterling
MACHINERY EXCHANGE

www.SterlingMachinery.com

CAPACITY OF LATHE

Swing over bed.....11¹/₈"
 Swing over saddle cross slide screw cutting lathes....6¹/₈"
 Swing over saddle cross slide turret lathe.....4¹/₂"

THREADS AND FEEDS

Quick change gear box and automatic apron
 Worm drive from lead screw spline for power feeds
 Friction clutch on power feeds
 Longitudinal feed .0018" to .1000" per spindle revolution
 Cross feed .25 times longitudinal feed
 Half nut drive from lead screw thread for thread cutting
 Threads—48 selections RH or LH—4 to 224 per inch
 Lead screw diameter and threads per inch 3/4"-8

BED

Width of bed across way.....6¹⁵/₁₆"
 Length.....43¹/₈" and 55¹/₈"
 Precision ground ways; 2 prismatic "V" ways and 2 flat ways

HEADSTOCK AND SPINDLE

Spindle Bearings: Sealed Ball Bearings, precision type with preloading
 Hardened and ground 52100 steel spindle
 Hole through spindle—1³/₈"
 Draw-in collet capacity.....1"
 Spindle Nose Diameter and threads per inch: 2¹/₄"-8
 Width of face of bull gear and back gears: 3/4"
 Drive plate diameter: 6"
 16 Spindle Speeds (Floor and Bench Models)
 direct drive:—325, 385, 470, 535, 885, 1020, 1230 and 1430 rpm.
 back gears:—50, 62, 75, 90, 145, 170, 200 and 235 rpm.
 16 Spindle Speeds (3-Drawer Cabinet and Pedestal Base Models)
 direct drive:—228, 318, 414, 490, 576, 676, 888 and 1230 rpm.
 back gears:—38, 53, 69, 96, 82, 112, 148 and 205 rpm.

CROSS SLIDE AND COMPOUND REST, SCREW CUTTING LATHE

Cross Slide Travel 6¹/₄"
 Cross Slide graduated in thousandths
 Cross feed screw mounted on self lubricating bronze bearings
 Compound Rest Travel 2¹/₄"
 Compound rest graduated in thousandths
 Compound swivel graduated 90° in both directions
 Tool post opening for tool holder shank 3/8" x 3/4"

CROSS SLIDE, TURRET LATHE

Cross Slide Travel 6"
 Cross Slide graduated in thousandths
 Cross feed screw mounted on self lubricating bronze bearings
 Adjustable double tool post with adjustable wedges
 Tool post slots 7/16" x 1¹/₁₆"

TAILSTOCK

Spindle Travel: 4"
 Spindle Graduations: 1/16"
 Morse Taper center: No. 2
 Tailstock set-over for taper turning: 1¹/₁₆"

TURRET

Distance across flats 5¹/₄"
 Six position, self indexing with adjustable stops
 Turret holes, diameter 5/8" regular—3/4" on special order
 Turret holes bored from headstock of lathe
 Maximum stroke of turret—Pilot Wheel Model: 7³/₄"...
 Lever Type: 4¹/₄"

COUNTERSHAFT ASSEMBLY—FLOOR AND BENCH MODELS

All "V" belt drive
 Two step motor pulley—Four step countershaft pulley
 Countershaft mounted on ball bearings
 Adjustable motor mounting bracket
 Countershaft assembly independently supported on patented 3 point suspension
 Countershaft assembly completely insulated with rubber to prevent vibration being transmitted to lathe
 Countershaft and all pulleys completely enclosed and guarded
 Automatic belt tension release when guard for cone pulleys is raised to change belt steps

UNDERNEATH DRIVE (Pedestal Models)

Two step motor pulley to countershaft drive, B section
 V-belt, Belt size, 40" x 5/8"
 Four step countershaft to jackshaft drive, B section V-belt, Belt size, 30" x 5/8"
 Double V-belt drive, Jackshaft to spindle, A section V-Belts, Belt sizes, 49" x 1/2"
 Jackshaft and countershaft mounting—Ball Bearing

MOTOR

3/4 HP Ball Bearing, 1750 RPM Motor is recommended
 If lathe is ordered without motor, specify bore of motor pulley to be furnished with lathe

EQUIPMENT INCLUDED WITH SCREW CUTTING LATHE

1 6" Drive Plate
 2 60° Centers
 1 Threading Dial
 1 Threading Chart
 1 Drum Reversing Switch
 Necessary Belts
 1 Spindle Nose Taper Adaptor No. 2 M.T.
 1 Tailstock Wrench
 1 Tool Post and Wrench
 1 Motor Pulley
 Parts List and Instruction Book

DIMENSIONS

Centers	Floor Models				
	Bed Length	Overall Length	Width	Height	
24"	43"	54"	30"	48 ¹ / ₂ "	
or	or	or	for all	for all	
36"	55"	66"	models	models	
Cabinet Models					
24"	43"	59"	21"	48 ³ / ₄ "	
or	or	or	for all	for all	
36"	55"	70 ¹ / ₂ "	models	models	

SCREW CUTTING LATHES

Lathe No.	Description	Ship. Wt. (Lbs.)
1915	Quick Change, Bench Model, 24" Centers, V-Belt Drive	505
1917	Quick Change, Bench Model, 36" Centers, V-Belt Drive	550
1920	Quick Change, Floor Model, 24" Centers, V-Belt Drive	615
1922	Quick Change, Floor Model, 36" Centers, V-Belt Drive	665
1925	Quick Change, 3-Drawer Cabinet Model, 24" Centers, V-Belt Drive	870
1927	Quick Change, 3-Drawer Cabinet Model, 36" Centers, V-Belt Drive	915
1955	Quick Change, Pedestal Cabinet Model, 24" Centers, V-Belt Drive	840
1957	Quick Change, Pedestal Cabinet Model, 36" Centers, V-Belt Drive	890

TURRET LATHES

1935	Quick Change, Pedestal Cabinet Model, 43" Bed, Lever Turret, V-Belt Drive	895
1935-2	Quick Change, Pedestal Cabinet Model, 43" Bed, Pilot Wheel Turret, V-Belt Drive	905
1937	Quick Change, Pedestal Cabinet Model, 55" Bed, Lever Turret, V-Belt Drive	945
1937-2	Quick Change, Pedestal Cabinet Model, 55" Bed, Pilot Wheel Turret, V-Belt Drive	955
1940	Quick Change, Floor Model, 43" Bed, Lever Turret, V-Belt Drive	670
1940-2	Quick Change, Floor Model, 43" Bed, Pilot Wheel Turret, V-Belt Drive	680
1942	Quick Change, Floor Model, 55" Bed, Lever Turret, V-Belt Drive	720
1942-2	Quick Change, Floor Model, 55" Bed, Pilot Wheel Turret, V-Belt Drive	730
1945	Quick Change, 3-Drawer Cabinet Model, 43" Bed, Lever Turret, V-Belt Drive	920
1945-2	Quick Change, 3-Drawer Cabinet Model, 43" Bed, Pilot Wheel Turret, V-Belt Drive	930
1947	Quick Change, 3-Drawer Cabinet Model, 55" Bed, Lever Turret, V-Belt Drive	970
1947-2	Quick Change, 3-Drawer Cabinet Model, 55" Bed, Pilot Wheel Turret, V-Belt Drive	980

Logan 10" SWING LATHES

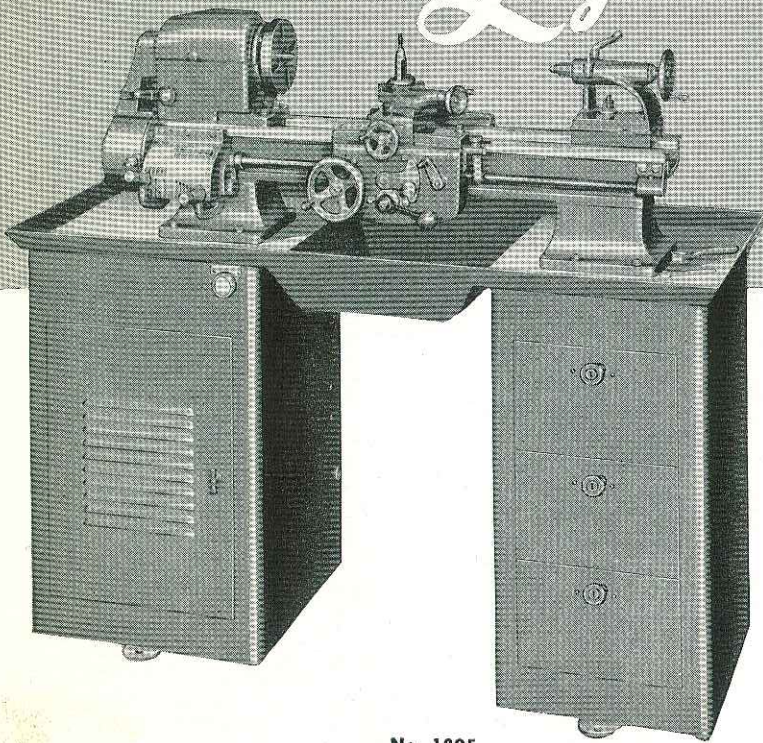

No. 1825
Screw Cutting Lathe on
3-Drawer Cabinet Base

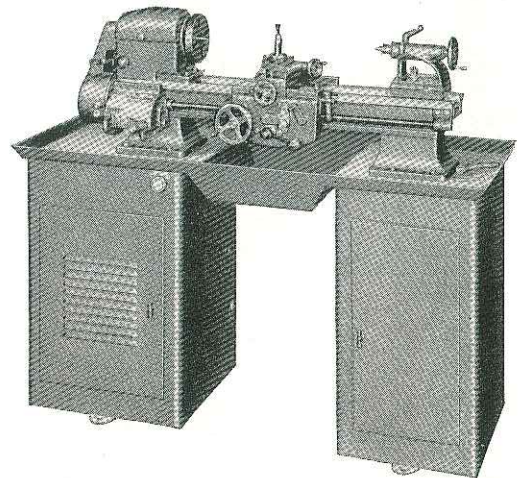

No. 1875
Screw Cutting Lathe
on Pedestal Cabinet Base

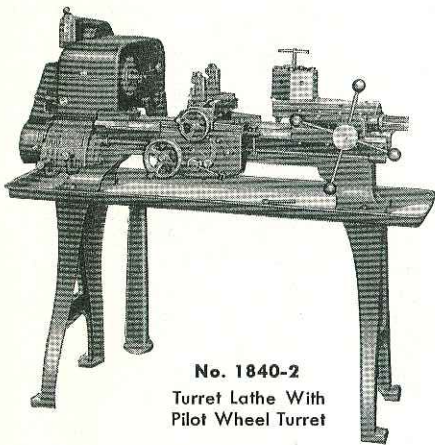

No. 1840-2
Turret Lathe With
Pilot Wheel Turret

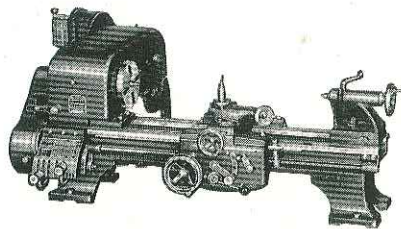

No. 1815
Quick Change Gear
Bench Model Lathe

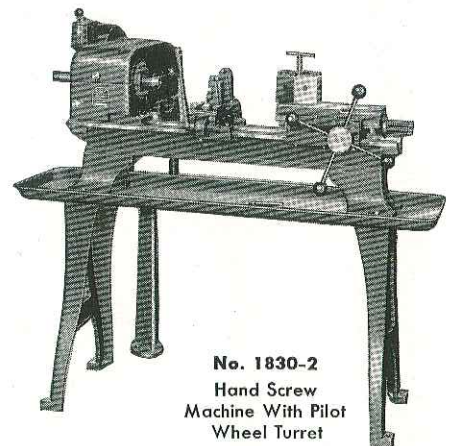

No. 1830-2
Hand Screw
Machine With Pilot
Wheel Turret

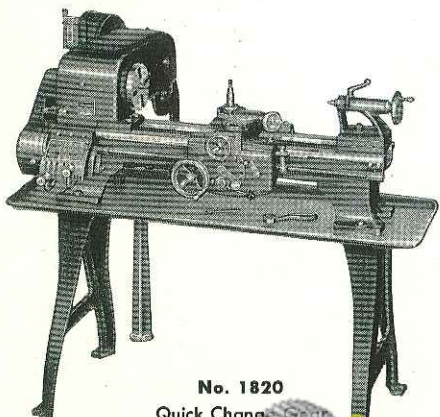

No. 1820
Quick Change Gear
Screw Cutting Lathe

For industry's great variety of medium and small lathe turning operations, these 10" swing Logans are tools of proven accuracy and economy. In school shops they have been the training tools of many of today's top flight metal workers. In advanced design features these 10" swing lathes match the larger Logan models. They have the Logan ball bearing spindle, V-belt drive, the Automatic Apron, and the precision ground, 2-V-way, 2-flat-way bed. Their versatility is increased by the complete line of accessories and attachments listed in the following section of this catalog. Their sustained accuracy and low cost performance is in the records of well-run shops. Rugged, precision ground, 2-V-way, 2-flat-way beds furnished flame hardened at only small added cost.

Sterling
MACHINERY EXCHANGE

www.SterlingMachinery.com

CAPACITY OF LATHE

- Swing over bed.....10 1/2"
- Swing over saddle cross slide—screw cutting lathes...6 1/8"
- Distance between centers.....24" or 31"
- Swing over saddle cross slide, turret lathe.....4 1/2"

THREADS AND FEEDS

- Quick change gear box and automatic apron
- Worm drive from lead screw spline for power feeds
- Friction clutch on power feeds
- Longitudinal feed .0018" to .1000" per spindle revolution
- Cross feed .25 times longitudinal feed
- Half nut drive from lead screw thread for thread cutting
- Threads—48 selections RH or LH—4 to 224 per inch.
- Lead screw diameter: 3/4"—8 thread

BED

- Width of bed across ways.....6 15/16"
- Bed Length.....43 1/8" or 50"
- Precision ground ways; 2 prismatic "V" ways and 2 flat ways.

HEADSTOCK AND SPINDLE

- Front bearing—double row ball bearing
- Rear bearing—single row ball bearing
- Hole through spindle.....25 3/32"
- Draw-in collet capacity.....1 1/2"
- Drive plate diameter.....6"
- Morse Taper with adaptor, No. 3—No. 2
- Size of centers used, Morse Taper No. 2
- Spindle nose diameter and threads per in. 1 1/2"-8
- Number of spindle speeds (except No. 1825 and No. 1875).....12
- Number of spindle speeds (No. 1825 and No. 1875)....16
- Spindle Speeds (all 10" lathes except No. 1875)
 - direct drive:—330, 425, 550, 880, 1100, and 1430 rpm.
 - back gears:—55, 70, 90, 145, 185, and 240 rpm.
- Spindle Speeds (for No. 1875 cabinet model only)
 - direct drive:—228, 318, 414, 576, 490, 676, 888 and 1230 rpm.
 - back gear drive:—38, 53, 69, 96, 82, 112, 148 and 205 rpm.

CROSS SLIDE AND COMPOUND REST, SCREW CUTTING LATHE

- Cross slide graduated in thousandths—Travel.....6 1/4"
- Compound rest top slide graduated in thousandths—Travel.....2 1/4"
- Compound rest swivel—graduated 90° in both directions
- Tool post opening for tool holder.....3/8 x 3/4"

CROSS SLIDE, TURRET LATHE

- Cross slide travel: 6"
- Cross slide graduated in thousandths

- Cross feed screw mounted on self lubricating bronze bearings
- Adjustable double tool post with adjustable wedges
- Tool post slots: 7/16" x 1 9/16"

TAILSTOCK

- Spindle travel.....2 3/8"
- Spindle graduations.....1/16"
- Morse Taper center.....No. 2
- Tailstock set over for taper turning.....11/16"

TURRET

- Distance across flats: 5 1/4"
- Six position, self indexing with adjustable stops
- Turret holes, diameter 5/8" regular—3/4" on special order
- Turret holes bored from headstock of lathe
- Maximum stroke of turret—Pilot Wheel Model: 7 3/4" . . .
- Lever Type: 4 1/4"

COUNTERSHAFT ASSEMBLY (Floor or Bench Models)

- All "V" belt drive
- Two step motor pulley—Three step countershaft pulley
- Countershaft mounted on ball bearings
- Adjustable motor mounting bracket
- Countershaft assembly completely insulated with rubber to prevent vibration being transmitted to lathe
- Countershaft and all pulleys completely enclosed and guarded
- Automatic belt tension release when guard for cone pulleys is raised

UNDERNEATH DRIVE (Cabinet Models)

- Two step motor pulley to countershaft drive.
- B Section V-belt, Belt size, 40" x 5/8"
- Four step countershaft to jackshaft drive.
- B section V-belt, Belt size, 30 x 5/8"
- Double V-belt drive, Jackshaft to spindle.
- A section V-belts, Belt sizes, 49" x 1/2"
- Jackshaft and countershaft mounting—Ball bearing

MOTOR

- Use 1/2 H.P. 1750 R.P.M. motor with sleeve bearings

EQUIPMENT WITH SCREW CUTTING LATHES

- | | |
|-------------------------|-----------------------------------|
| 1 6" Drive Plate | 1 No. 3—No. 2 Morse Taper Adaptor |
| 2 60° Centers | 1 Tool Post and Wrench |
| 1 Threading Dial | 1 Threading Chart |
| 1 Threading Chart | 1 Tailstock Wrench |
| 1 Drum Reversing Switch | 1 Motor Pulley |
| Necessary Belts | Parts List and Instruction Book |

OVERALL DIMENSIONS

- | | | |
|-------------------------|--------------|--------------|
| Model 1820—54" long | 30" wide | 48 1/2" high |
| Model 1821—61" long | 30" wide | 48 1/2" high |
| Model 1875—55 1/2" long | 20 1/2" wide | 48" high |

Lathe No.	SCREW CUTTING LATHES	Ship. Wt. (Lbs.)
1815	Quick Change, Bench Model, 24" Centers, V-Belt Drive.....	435
1816	Quick Change, Bench Model, 31" Centers, V-Belt Drive.....	470
1820	Quick Change, Floor Model, 24" Centers, V-Belt Drive.....	540
1821	Quick Change, Floor Model, 31" Centers, V-Belt Drive.....	575
1825	Quick Change, 3-Drawer Cabinet Model, 24" Centers, V-Belt Drive.....	790
1875	Quick Change, Pedestal Cabinet Model, 24" Centers, V-Belt Drive.....	765

TURRET LATHES

1830	Hand Screw, Floor Model, 43" Bed, Lever Turret, V-Belt Drive.....	540
1830-2	Hand Screw, Floor Model, 43" Bed, Pilot Wheel Turret, V-Belt Drive.....	560
1835	Quick Change, Pedestal Cabinet Model, 43" Bed, Lever Turret, V-Belt Drive.....	860
1835-2	Quick Change, Pedestal Cabinet Model, 43" Bed, Pilot Wheel Turret, V-Belt Drive.....	830
1840	Quick Change, Floor Model, 43" Bed, Lever Turret, V-Belt Drive.....	590
1840-2	Quick Change, Floor Model, 43" Bed, Pilot Wheel Turret, V-Belt Drive.....	600
1845	Quick Change, 3-Drawer Cabinet Model, 43" Bed, Lever Turret, V-Belt Drive.....	845
1845-2	Quick Change, 3-Drawer Cabinet Model, 43" Bed, Pilot Wheel Turret, V-Belt Drive.....	855



Logan 9" SWING LATHES

- 28" or 17" Between Centers
- 1/2" Collet Capacity
- 25/32" Spindle Hole
- Quick or Plain Change Gears
- Automatic or Plain Apron

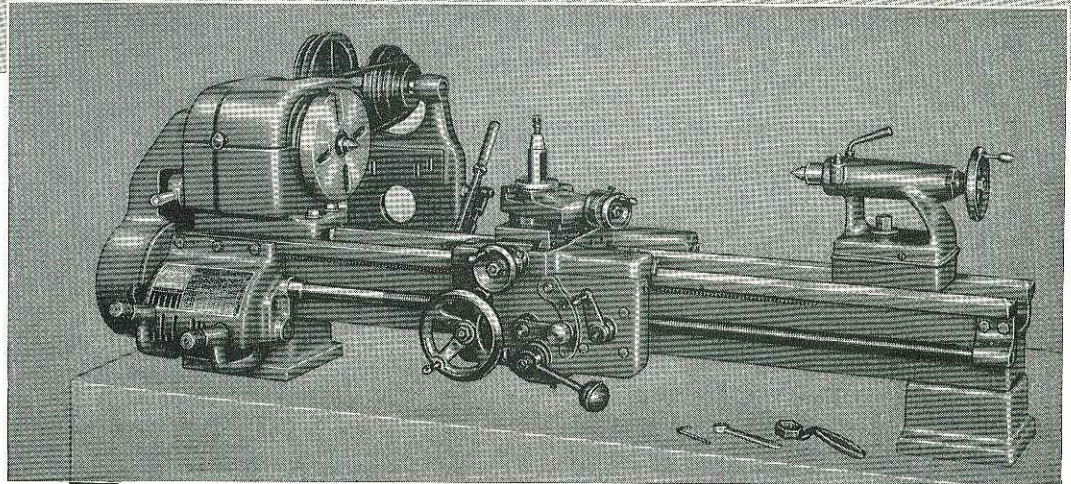

No. 9B28-1 Quick Change Gears, Automatic Apron

FOR situations where a smaller lathe is indicated, here is the sustained accuracy inherent in Logan advanced design. In addition to their accuracy, these No. 9B series lathes combine remarkable work capacity and versatility. Ball bearing spindles provide a range of 55 to 1450 rpm without adjustment and permit full use of high speed cutting tools. Ruggedly proportioned throughout, they take heavy cuts smoothly. On small work in machine shops, tool rooms and manufacturing these lathes can be depended upon for precision results. For the farm and home work shop they provide professional standards of performance with the utmost economy.

Four Models with 28" Centers	
Lathe No.	Ship. Wt. (Lbs.)
No. 9B28-1 Quick Change Gears, Automatic Apron	310
No. 9B28-21 Quick Change Gears, Plain Apron	300
No. 9B28-41 Plain Change Gears, Automatic Apron	300
No. 9B28-61 Plain Change Gears, Plain Apron	290

Four Models with 17" Centers	
Lathe No.	Ship. Wt. (Lbs.)
No. 9B17-1 Quick Change Gears, Automatic Apron	285
No. 9B17-21 Quick Change Gears, Plain Apron	275
No. 9B17-41 Plain Change Gears, Automatic Apron	275
No. 9B17-61 Plain Change Gears, Plain Apron	265
No. LA12-2 Threading Dial, Ship. Wt. 3 lbs.	

S P E C I F I C A T I O N S

CAPACITY OF LATHE

Swing over bed.....	9 1/4"
Swing over cross slide.....	5"
Distance between centers.....	28" or 17"

THREADS AND FEEDS

Reversible power longitudinal feed.
 Reversible power cross feed (on Automatic Apron Only).
 Threads—48 selections RH or LH
 4 to 224 per inch

BED

Width of Bed.....	6 1/16"
Bed length	44" or 33"
Precision ground ways. 2 prismatic "V" ways and 2 flat ways.	

HEADSTOCK AND SPINDLE

Spindle mounted on greased-sealed ball bearings preloaded in the headstock at the factory.
 Morse Taper with adapter No. 3, No. 2.
 Back gear shaft bearings—self-lubricating bronze bearings.
 Size of centers used. Morse Taper No. 2.
 Hole thru spindle..... 25/32"
 Spindle nose diameter and threads per inch 1 1/2" - 8
 V-belt cone pulley for "A" cross section.
 V-belts 1/2" wide, 9/32" thick.
 Number of spindle speeds..... 12
 Spindle speeds, back gears engaged: 55, 80, 112, 144, 200 and 253 R.P.M.
 Spindle speeds, direct belt driven, 353, 459, 645, 831, 1157 and 1450 R.P.M.

TAILSTOCK

Spindle travel 2 3/8"
 Spindle graduations 1/16"
 Morse taper center..... No. 2
 Tailstock top sets over for taper turning 1/2"

CARRIAGE AND CROSS SLIDE

Cross slide graduated in thousandths, travel 5 1/2"
 Cross feed screw mounted on self-lubricating bronze bearings.
 Compound rest swivel—graduated 90° in both directions.
 Tool post opening for tool holder shank 3/8 x 3/4"
 Size of cutter bits used..... 1/4" Sq.

COUNTERSHAFT ASSEMBLY

2 speed "V" motor pulley..... 2 3/8 - 2 7/8"
 2 speed "V" countershaft pulley... 6" - 6 3/8"
 30" x 1/2" "V" belt from motor to countershaft.
 44" x 1/2" "V" belt—countershaft to headstock.
 3 steps "V" belt cone pulley mounted on countershaft.
 Countershaft mounted on self lubricating bronze bearings.
 Motor mounted directly on countershaft bracket.
 Countershaft mounted on bench independent of lathe.

LATHE EQUIPMENT

1—6" Drive Plate
 1—No. 3-No. 2 Morse taper adapter
 1—Tool post and wrench
 1—Motor pulley
 2—60° centers
 1—Threading chart
 1—Tailstock Wrench
 Necessary Belts
 Parts List and Instruction Book

OVERALL DIMENSIONS

(including Countershaft Assembly)
 (28" Centers) 50" long, 28" wide, 15 1/2" high
 (17" Centers) 39" long, 28" wide, 15 1/2" high

MOTOR

Use 1/3 H.P. 1750 R.P.M. Motor—Suitable for sidewall mounting. If lathe is ordered without motor, specify bore of motor pulley to be furnished with lathe.



www.SterlingMachinery.com

CHUCKS AND ACCESSORIES

3-JAW UNIVERSAL CHUCKS

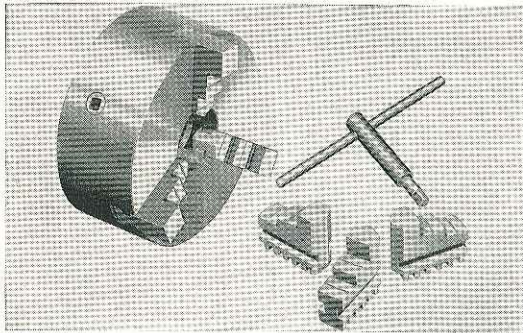

Furnished with two sets of jaws, one set for inside chucking and the other for outside chucking. Jaws are automatically self centering. Complete with threaded back plate except No. 536 and 531, on which the body of the chuck itself is threaded. When ordered with a lathe, chuck is fitted to the lathe.

Cat. No.	Chuck Size	Fitted for Spindle	Logan Lathe Size	Ship. Wt. Lbs.
536	5" Med. Duty	1 1/2"-8 thd.	9"-10"	12
531	5" Hvy. Duty	1 1/2"-8 thd.	9"-10"	20
1063/AC-108	6" Hvy. Duty	1 1/2"-8 thd.	9"-10"	22
1063/AC-105	6" Hvy. Duty	2 1/4"-8 thd.	11"-12"-14"	23
1063/2300	6" Hvy. Duty	L-00	12"-14"	23

4-JAW INDEPENDENT CHUCKS

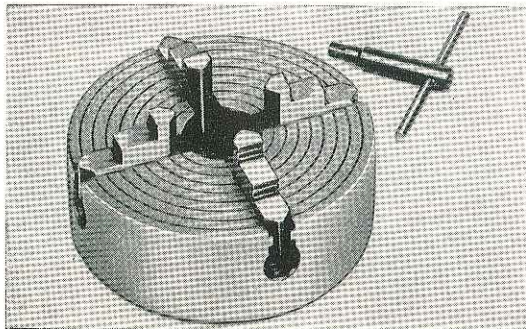

Jaws are independently adjusted and are reversible. The body of No. 444 Chuck is threaded. All other independent chucks are furnished with threaded back plates fitted for the lathe spindle.

Cat. No.	Chuck Size	Fitted for Spindle	Logan Lathe Size	Ship. Wt. Lbs.
444	6" Med. Duty	1 1/2"-8 thd.	9"-10"	13
1064/AC-126	6" Hvy. Duty	1 1/2"-8 thd.	9"-10"	20
1064/AC-117	6" Hvy. Duty	2 1/4"-8 thd.	11"-12"-14"	21
1064/2303	6" Hvy. Duty	L-00	12"-14"	21
1284/AC-117	8" Hvy. Duty	2 1/4"-8 thd.	11"-12"-14"	27
1284/2303	8" Hvy. Duty	L-00	12"-14"	27
6310/6312	10" Hvy. Duty	2 1/4"-8 thd.	14"	90
6310/2304	10" Hvy. Duty	L-00	14"	90

JACOBS COMMUTATOR CHUCK KIT

Contains a Jacobs Armature Driving Chuck, 1/4 to 3/4" capacity, and a Center Rest Chuck also 1/4 to 3/4" capacity. Both chucks equipped with No. 2 Morse Taper Arbors to fit the headstock and tailstock.

No. 459 Shipping wt. 9 lbs.

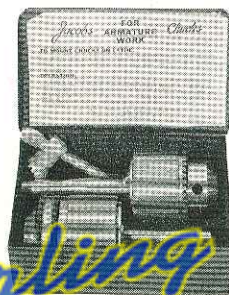

Sterling
MACHINERY EXCHANGE

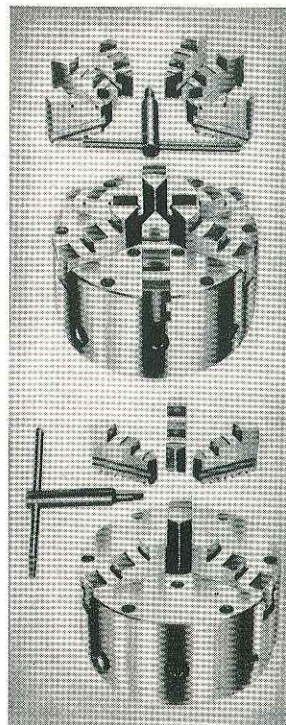

6-JAW BUCK AJUST-TRU CHUCKS

The 6-jaw Buck chuck replaces both collets and step collets. Spindle hole capacity from 1/8" to 1 1/2" and step jaw capacity from 1/8" to 5". All told this single chuck handles the work of 93 collets. Accuracy and speed of operation is the same as for the 3-jaw Ajust-tru chucks.

Cat. No.	Chuck Size	Fitted for Spindle	Logan Lathe Size	Ship. Wt. Lbs.
3662/AC-113	6"	1 1/2"-8 thd.	9"-10"	36
3662/AC-114	6"	2 1/4"-8 thd.	11"-12"-14"	36
3662/2305	6"	L-00	12"-14"	36

3-JAW BUCK AJUST-TRU CHUCKS

These chucks have the accuracy of 4-jaw chucks plus the speed and versatility of universal chucks. Work can be chucked to .0005" precision in one minute, and duplicate parts can be re-chucked with the same accuracy with no further adjustment. They eliminate most needs for stub arbors, mandrels, and special fixtures.

Cat. No.	Chuck Size	Fitted for Spindle	Logan Lathe Size	Ship. Wt. Lbs.
3634/AC-113	6"	1 1/2"-8 thd.	9"-10"	35
3634/AC-114	6"	2 1/4"-8 thd.	11"-12"-14"	35
3634/2305	6"	L-00	12"-14"	35
4733/6385	7 1/2"	2 1/4"-8 thd.	11"-12"-14"	44
4733/2301	7 1/2"	L-00	12"-14"	44
6309/6311	9"	2 1/4"-8 thd.	14"	88
6309/2302	9"	L-00	14"	88

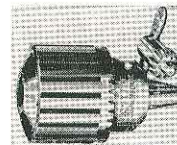

JACOBS DRILL CHUCKS

No. 451 0-1/2" cap. Requires No. 447 or 445 Arbor. Ship. wt. 2 1/2 lbs.

No. 452 3/16"-3/4" cap. Requires No. 448 or 446 Arbor. Ship. wt. 3 1/2 lbs.



JACOBS CENTER REST CHUCK

1/4"-3/4" capacity. Requires No. 448 or 446 Arbor.

No. 455 Shipping wt. 2 lbs.



JACOBS HEADSTOCK CHUCKS

No. 453 1/8"-5/8" capacity. For 1 1/2"-8 thread spindle. Ship. wt. 3 1/2 lbs.

No. 454 3/16"-3/4" capacity. For 1 1/2"-8 thread spindle. Ship. wt. 4 1/2 lbs.



CHUCK ARBORS

No. 445 No. 3 M.T. for No. 451 Jacobs Chuck. Shipping wt. 1 lb.

No. 446 No. 3 M.T. for No. 452 and 455 Jacobs Chucks. Ship. wt. 1 lb.

No. 447 No. 2 M.T. for No. 451 Jacobs Chuck. Shipping wt. 1 lb.

No. 448 No. 2 M.T. for No. 452 and 455 Jacobs Chucks. Ship. wt. 1 lb.

CHUCK ADAPTERS (Unfinished)

Threaded. Unfinished face to be fitted to chucks.

Cat. No.	Threaded	Chuck Diam.	Ship. Wt.
AC-101	1 1/2"-8 thd.	5"	4 lbs.
AC-104	1 1/2"-8 thd.	6"	7 lbs.
AC-107	2 1/4"-8 thd.	6"	7 lbs.

CHUCK ADAPTERS (Semi-Finished)

Cat. No.	Threaded	Chuck No.	Wt.	Cat. No.	Threaded	Chuck No.	Wt.
AC-105	2 1/4"-8	1063	5 lbs.	2301	L-00	4733	9 lbs.
AC-108	1 1/2"-8	1063	5 lbs.	2302	L-00	6309	15 lbs.
AC-113	1 1/2"-8	3634 3662	5 lbs.	2303	L-00	1064 1284	5 lbs.
AC-114	2 1/4"-8	3634 3662	5 lbs.	2304	L-00	6310	7 lbs.
AC-117	2 1/4"-8	1064 1284	5 lbs.	2305	L-00	3634 3662	6 lbs.
AC-126	1 1/2"-8	1064	5 lbs.	6311	2 1/4"-8	6309	8 lbs.
2300	L-00	1063	6 lbs.	6312	2 1/4"-8	6310	15 lbs.
				6313	2 1/4"-8	4733	8 lbs.

COLLETS, COLLET ATTACH

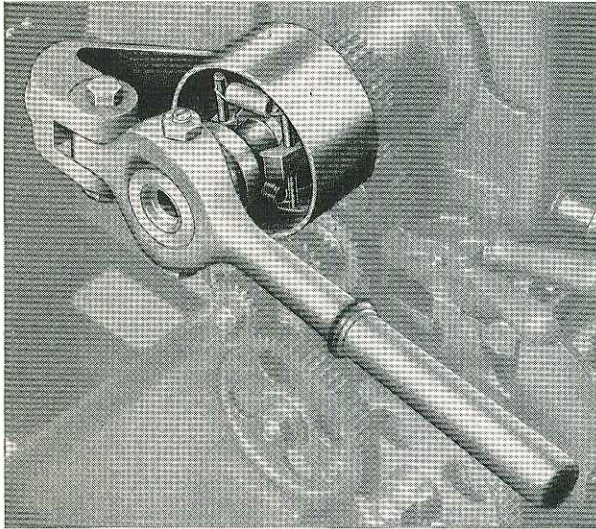

PRODUCTION COLLET ATTACHMENT

Hand lever type draw-in collet chuck opens and closes while lathe spindle is in motion. Fast and accurate for production work. Bar stock may be hand fed through lathe spindle. In addition to closing mechanism and hollow draw bar, a spindle nose cap, closing sleeve and wrench are furnished.

Cat. No.	For Lathe	Collet Used	Max. Collet Capacity	Ship. Wt. Lbs.
AC-166	800 and 1800 series	AC-30	1/2"	12
AC-360-2	11" lathes serial #52576 and over	475	1"	18
AC-2360	12" lathes serial #68248 and under	475	1"	20
2385	12" lathes serial #68249 and over threaded spindle	475	1"	22
2395	12" lathes with L-00 spindle	475	1"	23
6305	14" lathes. Threaded spindle	475	1"	30
6345	14" lathes. L-00 spindle	475	1"	32

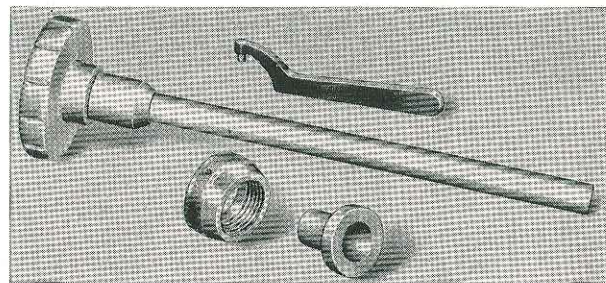

DRAW-IN COLLET CHUCK ATTACHMENTS

All attachments consist of hollow draw bar, tapered closing sleeve, spindle nose cap and spindle cap wrench.

Cat. No.	For Lathe Size	Collet Used	Max. Collet Capacity	Ship. Wt. Lbs.
AC-251	9"	AC-30	1/2"	4
AC-152	10"	AC-30	1/2"	5
LA-1050-1	11" lathes serial #52576 and over	475	1"	8
AC-2050	12" lathes serial #68248 and under	475	1"	10
2380	12" lathes serial #68249 and over threaded spindle	475	1"	11
2390	12" with L-00 spindle	475	1"	12
6300	14" lathes threaded spindle	475	1"	12
6340	14" lathes L-00 spindle	475	1"	13

HEAVY DUTY COOLANT PUMP

High Pressure—
Gear Type

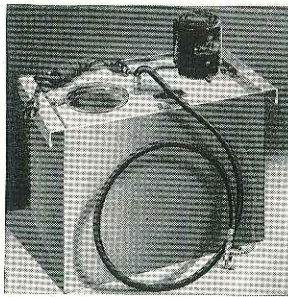

Light weight, portable. Operates independently of the machine tool. Delivers from 90 gallons per hour to a few drops. 20 lbs. pressure capacity. 1/25 H.P., 115 V., AC 60 Cy. 1 phase Motor. 7 1/2 gallon container has 5" bowl screen strainer. Includes 4 ft. of 3/8" Neoprene hose with flow control pet cock and 12" of flexible feed spout. 5 1/2 ft. of rubber-covered electric cord with plug and motor switch.

No. 525-1 Ship. wt., 38 lbs.

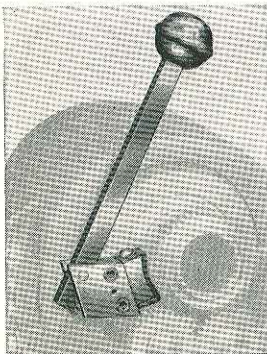

SPINDLE BRAKE

Fits any Logan 11" Swing Lathe. Replaceable leather shoe applies friction to spindle for rapid brake. Spring return lever.

No. AC-325 Spindle brake with screws for attaching. Shipping weight, 10 lbs.

METAL SPINNING ATTACHMENT

Equips any 10", 11" or 12" Logan Lathe for metal spinning operations. Rest is 10 inches long. Easily attached to or detached from the lathe.

No. AC-385 Shipping wt., 17 lbs.

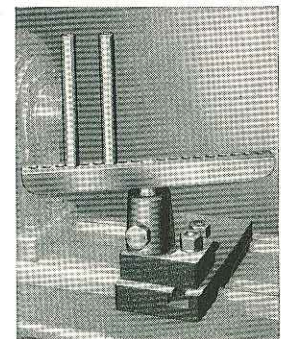

PALMGREN MILLING ATTACHMENT

Mounted in 10 seconds on any tool post up to 1 1/2" diameter. Fits Logan 9", 10", 11" and 12" Lathes. Allows lathe to be used for slotting, milling, sawing, grooving, squaring, recessing, etc. Jaws are 2 1/2" wide, 1 1/16" deep, and open to 2 1/2".

No. 250 Shipping weight, 14 lbs.

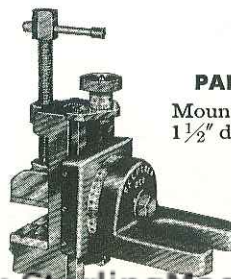

Sterling
MACHINERY EXCHANGE

www.SterlingMachinery.com

LEVER-MATIC COLLET CHUCK WITH CO-NETIC COLLET

Easily mounted directly on the threaded spindle nose, the Lever-Matic "runs as true as the spindle." Finger tip grip control provides a tremendously powerful grip for tough steel under a heavy cut, or a firm, yet gentle grip on tubing. Takes maximum bar stock capacity of the spindle. Permits internal and external chucking by hand lever or air cylinder. Runs cool. Provides quickest, easiest collet and arbor changes. Precision built from high grade steel.

The Co-Netic Collet used with the Lever-Matic has a full-floating, self-aligning action in each jaw, assuring uniform pressure over entire length.

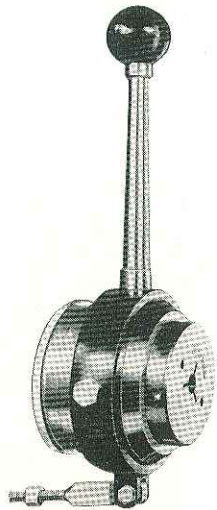

Lever-Matic Sizes

Cat. No.	Collet Capacity	Lathes Fitted (or Spindle Fitted)	Ship. Wt. (lbs.)
100	1"	Logan 10"	19
150	1 1/2"	Logan 11", 12", 14"	41
150-L	1 1/2"	For L-100 Spindle Fits 12" and 14" Logan Lathes with L-00 Spindle	41

Co-Netic Collets

Cat. No.	Size	Lever-Matic Chuck Fitted	Ship. Wt. (lbs.)
110	1/8" to 1" by 32nds	No. 100	1
160	3/16" to 1 1/2" by 32nds	No. 150 and No. 150-L	2

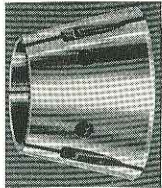

COLLET RACKS

Clamp to rear way of Logan Lathe bed. Provide convenient storage and protection for a full set of collets.

No. AC-340 for AC-30 Collets on 9" and 10" Lathes. Ship. wt., 7 lbs.

No. AC-350 for AC-50 Collets on 10" Lathes. Ship. wt., 7 lbs.

No. AC-345 for No. 475 Collets on 11" and 12" Lathes. Ship. wt., 7 lbs.

No. 6325 for No. 475 Collets on 14" Lathes. Ship. wt., 7 lbs.

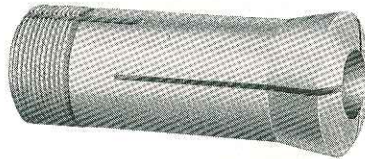
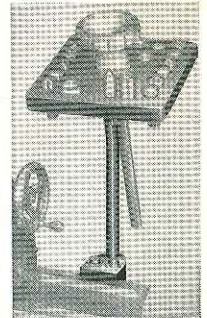

DRAW-IN COLLETS

No. AC-30 Sizes 1/16" to 1/2" by 32ds. Round. Ship. wt., 1/2 lb.

No. AC-35-S Set of 15 #AC-30 Collets, 1/16" to 1/2" by 32ds. Ship. wt. 7 lbs.

No. 475 Sizes 1/16" to 1" by 32ds. Round. Ship. wt. 3/4 lb.

No. 477-S Set of 31 #475 Collets, 1/16" to 1" by 32ds. Ship. wt. 18 lbs.

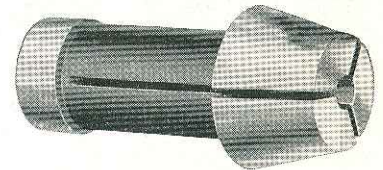

PUSH TYPE COLLETS

No. AC-50 Used with #LA-32-34 Bar Feed on Hand Screw Machines only. Sizes 1/16" to 5/8" by 32ds. Round. Ship. wt. 1/2 lb.

No. AC-45-S Set of 19 #AC-50 Collets, 1/16" to 5/8" by 32ds. Ship. wt. 8 lbs.

AUTOMATIC SAFETY GEAR

- Guards Gear Train Against Overload Shock
- Installed in Your Own Shop in 15 Minutes
- Fits Logan 9", 10", 11", 12" and 14" Quick Change Gear Lathes

In school shops or where operators are inexperienced, here is insurance against heavy repairs. When a sudden overload of the carriage feed occurs the Automatic Safety Gear instantly throws out and a clicking noise warns of the overload. On correction of the overload condition, the Safety Gear automatically resumes engaged position. By its automatic throw-out action, the Automatic Safety Gear protects all lathe gears from spindle to gear box in case the carriage or the tool becomes jammed against movement. It also protects the gears within the gear box for all except 72 threads per inch and finer, or corresponding feeds, where there is tremendous torque build-up within the gear box.

No. LB-240 Fits Logan 9" Quick Change Gear Lathes. Shipping weight, 7 lbs.

No. LA-775 Fits Logan 10" and 11" Quick Change Gear Lathes with Serial Numbers 67839 and over. Shipping weight 7 lbs.

No. LA-774 Fits Logan 10" and 11" Quick Change Gear Lathes with Serial Number 67838 and under and 2900 Series 12" Lathes. Shipping weight 9 lbs.

No. 2410 Fits Logan 12" 2500 Series Lathes and all 14" Lathes. Shipping weight 7 lbs.

No. LB-240, No. LA-775 or No. 2410 will, on request, be factory-installed on a new lathe.

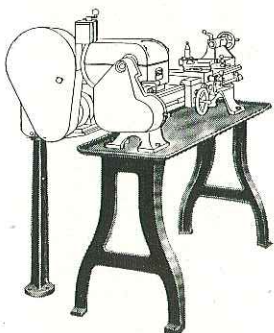
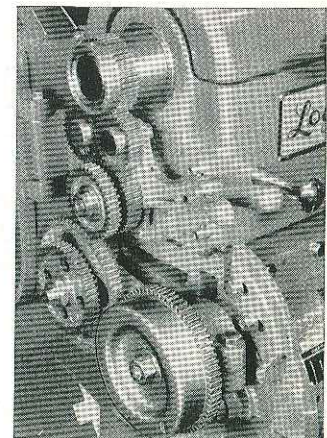

SETS FOR CONVERSION OF BENCH MODELS TO FLOOR MODELS

Each set includes Pan, Legs and Countershaft support

No. 415 1" Deep Chip Pan, for 10" Lathes, 24" Centers. Ship. wt., 118 lbs.

No. 418 1 1/2" Deep Oil Pan, for 10" Lathes, 24" Centers. Ship. wt., 122 lbs.

No. 417 1 1/2" Deep Oil Pan, for 10" Lathes, 31" Centers. Ship. wt., 125 lbs.

No. LA-1072 1 1/2" Deep Oil Pan, for 11" Lathes, 24" Centers. Ship. wt., 128 lbs.

No. LA-1078 1 1/2" Deep Oil Pan, for 11" Lathes, 36" Centers. Ship. wt., 130 lbs.

Sterling
MACHINERY EXCHANGE

www.SterlingMachinery.com

Logan ACCESSORIES

LEVER TAILSTOCKS

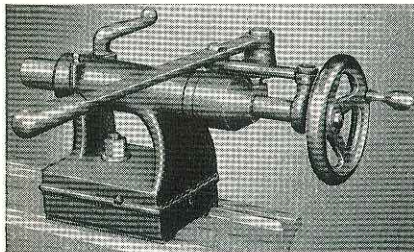

Provides lever operation to the tailstock in addition to the regular handwheel tailstock operation. Particularly valuable for repeat operations in production.

Cat. No.	For Lathe	Lever Stroke	Morse Taper	Ship. Wt.
AC-240	#1400	2 3/4"	No. 2	15 lbs.
LB-192	#9B	2 3/4"	No. 2	15 lbs.
AC-241	10"	2 3/4"	No. 2	30 lbs.
AC-375	11"	4"	No. 2	34 lbs.
AC-384	12"	4"	No. 2	45 lbs.

STANDARD TAILSTOCKS

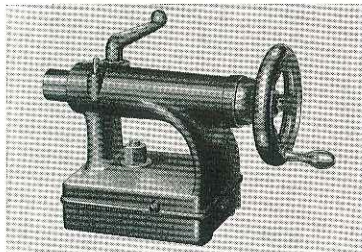

Tailstock assemblies if purchased for a turret lathe may be used to replace the turret for regular lathe operations. (Compound rest assemblies shown on the right may be ordered to replace the double tool post cross slide on a turret lathe.)

Cat. No.	For Lathe Size	Ship. Wt.
LA-3-1	10"	24 lbs.
LA-1065	11"	29 lbs.
2065	12"	32 lbs.

COMPOUND REST ASSEMBLIES

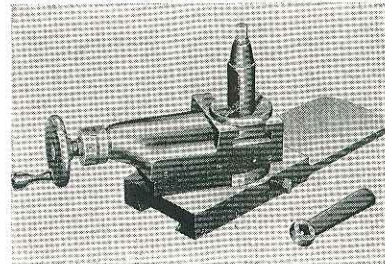

Compound rest assemblies may be ordered to replace the double tool post cross slide on turret lathes to convert for regular lathe operation. Also see tailstock assemblies on left. In ordering compound rest assemblies, give serial number of lathe on which it is to be used.

Cat. No.	For Lathe Size	Ship. Wt. Lbs.
LA-49-4	10" Lathes, serial #50843 and over. For all 11" lathes.	13
2085	12" Lathes, #2500 series.	25

QUICK CHANGE GEAR ATTACHMENT



Converts a Logan plain change gear lathe for quick change gear operation

Provides 48 threads and feeds in either direction. Screw threads from 8 to 224 per inch. Two lever adjustment. Changing 24-tooth stud gear for 48-tooth stud gear, also furnished, provides additional threads of from 4 to 7 per inch. Complete with a replacement lead screw, parts and installation instructions. Attachments have longitudinal power feed and power cross feed from .0044" to .2500" per spindle revolution.

No. LA-1200-1—For 10" and 11" lathes, 24" centers. Ship. wt., 24 lbs.

No. LA-959-1—For 10" Lathes, 31" centers. Ship. wt., 24 lbs.

No. LA-958-1—For 11" Lathes, 30" centers. Ship. wt., 26 lbs.

LOGAN METRIC TRANSPOSING GEARS

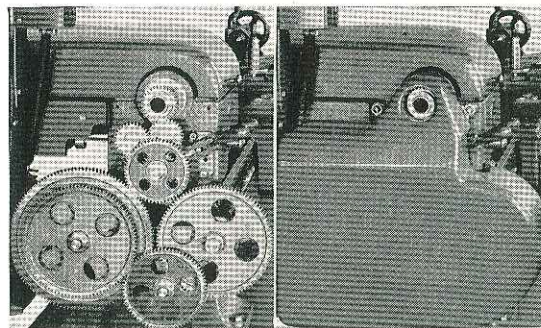

Without Gear Guard

With Gear Guard

Equip Logan 10" and 11" lathes to cut metric screw threads

Each of these complete sets includes bracket, gear guards and transposing gear chart. Each equips a standard Logan Lathe to cut right hand and left hand metric screw threads ranging from 6 mm. pitch to .020 mm. pitch. All gears semi-steel, 16 pitch, 1/16" wide and carefully machined.

No. AC-130 For 10" Plain Change Gear Lathes. Shipping weight, 29 lbs.

No. AC-143 For 10" Quick Change Gear Lathes with Serial No. 46561 and up. Shipping weight, 35 lbs.

No. AC-320 For 11" Quick Change Gear Lathes. Shipping weight, 35 lbs.

LATHES FACTORY EQUIPPED WITH TRANSPOSING GEARS . . .

May be specified by prefixing the letter "M" to the catalog number of the lathe ordered. In addition to metric transposing gears, gear guards, bracket and metric transposing chart, standard gears, gear bracket and chart necessary for cutting English screw threads are also shipped with these "M" lathes.

Sterling
MACHINERY EXCHANGE

www.SterlingMachinery.com

HEXAGONAL TURRET ASSEMBLIES

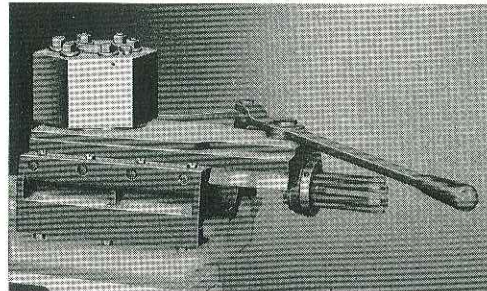
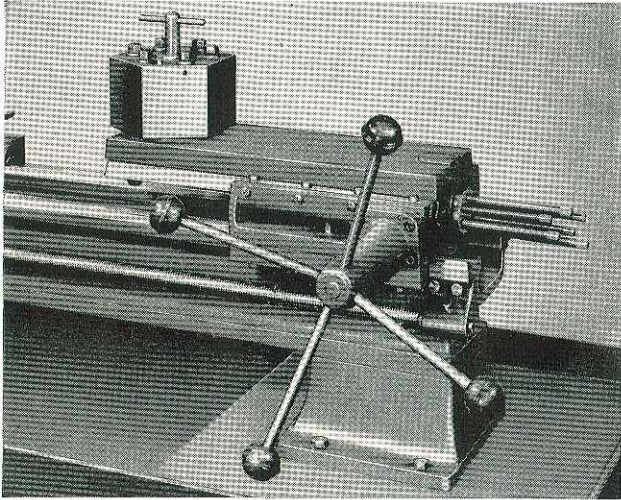

Six Position—Self Indexing
Pilot Wheel Model (at left)— $7\frac{3}{4}$ " Maximum Stroke
Lever Operated Model (above)— $4\frac{1}{4}$ " Maximum Stroke

Fit bedways of Logan 10", 11" and 12" Screw Cutting Lathes. Interchangeable with the tailstock, and used with a Double Tool Post Cross Slide to replace the compound rest, they convert such a lathe into a turret lathe. Extra heavy construction assures maximum smoothness and accuracy. Turret lock furnished on pilot wheel models provides increased rigidity for heavy cuts. $5\frac{1}{4}$ " across turret head flats—23" maximum distance, end of spindle to turret face—adjustable gibs on side—furnished unbored. Can be bored at factory at no extra charge if ordered with a lathe and if so specified. Specify $\frac{5}{8}$ " or $\frac{3}{4}$ " turret holes.

No. 1A-70 Pilot Wheel Type. $7\frac{3}{4}$ " max. stroke. Shipping wt., 110 lbs.

No. 1A-65 Lever Type. $4\frac{1}{4}$ " max. stroke. Shipping wt., 97 lbs.

TURRET TOOL POSTS

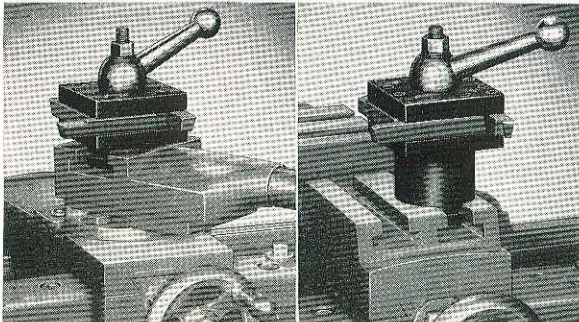

Quickly set up on the T-slot of a compound rest. Mount four tools up to $\frac{3}{8}$ ". 12 stations available, with three working positions for each tool. On jobs requiring less than four tools, duplicate tools may be set up for uninterrupted production. Square tool block indexes at 30° intervals, providing a quick set-up for threading.

For Screw Cutting Lathes

No. 512 For 10" Screw Cutting Lathes, Serial Number 50843 and Over. For all 11" and 12" Screw Cutting Lathes. Shipping wt., 4 lbs.

No. 513 For 10" Screw Cutting Lathes, Serial Number 50842 and Under. Shipping wt., 4 lbs.

No. 612 For 14" Screw Cutting Lathes. Ship. wt., 17 lbs.

For Turret Lathes

No. 514 For all 10", 11" and 2900 series 12" Turret Lathes. Shipping wt., 5 lbs.

No. 2094 For 2500 series 12" Turret Lathes. Shipping wt., 6 lbs.

No. 521 TAILSTOCK TURRET

Fits in No. 2 Morse Taper of Tailstock

Finger tip control rotates 6 tools in direct line with spindle. $2\frac{1}{2}$ " diameter. $\frac{5}{8}$ " turret holes. Shipping wt., 4 lbs.

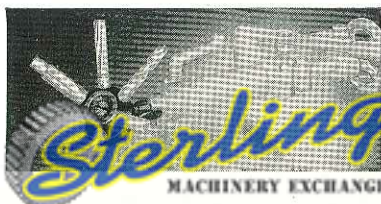

DOUBLE TOOL POST CROSS SLIDES

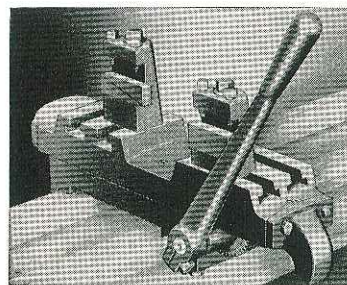

Lever Operated

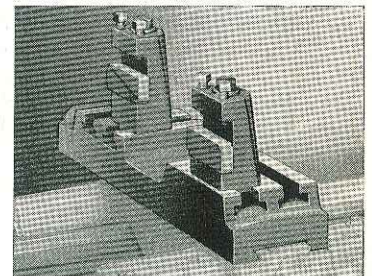

Manual Feed

Clamps directly to lathe bed. Lever operated. Has adjustable stops with maximum travel of 3". Adjustable wedges for tool holder slots included.

No. 1A-25-1 For all Logan 10" Lathes. Ship. Wt., 38 lbs.

No. 1A-1108 For all Logan 11" Lathes. Ship. Wt., 39 lbs.

No. 1A-29-1-L Same as LA-29-1 but with added lever operation. Ship. Wt., 27 lbs.

No. 2095-L Same as 2095 but with added lever operation. Ship. Wt., 30 lbs.

Replaces compound rest for hand wheel or power cross feed operation. In ordering double tool post cross slides, give serial number of lathe on which it is to be used.

No. 1A-29-1 For Logan 10" Lathes, serial #29568 and over. For all Logan 11" Lathes. Ship. Wt., 24 lbs.

No. 2095 For 12" Lathes, 2500 series. Ship. Wt., 27 lbs.

Logan L A T H E

TOOL HOLDERS

For 9", 10", 11" and 12" Logan Lathes, 3/8" x 3/4" Shanks

Drop forged steel heat treated tool holders individually boxed and including wrench and tool bit.

Cat. No.	Description	Cutter Size	Ship. Wt.
550	L. H. Turning Tool Holder	1/4" sq.	1 lb.
551	R. H. Turning Tool Holder	1/4" sq.	1 lb.
552	Straight Turning Tool Holder	1/4" sq.	1 lb.
553	Threading Tool Holder	60° thread	1 lb.
554	R. H. Cut-off Tool Holder	3/32 x 3/8"	1 lb.
557	Straight Cut-off Tool Holder	3/32 x 3/8"	1 lb.
555	Knurling Tool Holder	Med. Dia. Knurls	1 lb.
556	Boring Tool Holder	1/4" bar	1 lb.
549	Tool Holder Set. One each of above. Eight tool holders in a steel box.		7 lbs.
563	Extra Threading Cutter, 60°, for 553 Tool Holder		1/2 lb.
564	Extra Cut-off Blade for 554 or 557 Tool Holder		1/4 lb.
565	Extra Diamond Knurls for 555 Tool Holder. Specify fine, medium, or coarse.		1/4 lb.

For 14" Logan Lathes, 1/2" x 1 1/8" Shanks

650	L. H. Turning Tool Holder	5/16" sq.	1 1/2 lbs.
651	R. H. Turning Tool Holder	5/16" sq.	1 1/2 lbs.
652	Straight Turning Tool Holder	5/16" sq.	1 1/2 lbs.
653	Threading Tool Holder	60° Thread	1 1/2 lbs.
654	R. H. Cut-off Tool Holder	1/8 x 3/4"	1 1/2 lbs.
657	Straight Cut-off Tool Holder	1/8 x 3/4"	1 1/2 lbs.
655	Knurling Tool Holder	Med. Dia. Knurls	1 1/2 lbs.
663	Extra Threading Cutter, 60°, for 653 Tool Holder		1/2 lb.
664	Extra Cut-off Blade for 654 or 657 Tool Holder		1/4 lb.
665	Extra Diamond Knurls for 655 Tool Holder. Specify fine, medium, or coarse.		1/4 lb.



SOLID BORING BAR

Used with No. 556 Boring Tool Holder. Can be ground for internal thread cutting as well as for boring.

Catalog No.	Size	Ship. Wt.
570-A	1/8 x 4"	1/4 lb.
570-B	3/16 x 4 1/2"	1/4 lb.
570-C	1/4 x 5"	1/4 lb.
570-D	5/16 x 6"	1/4 lb.
570-E	3/8 x 7"	1/2 lb.
570-F	1/2 x 8"	1/2 lb.

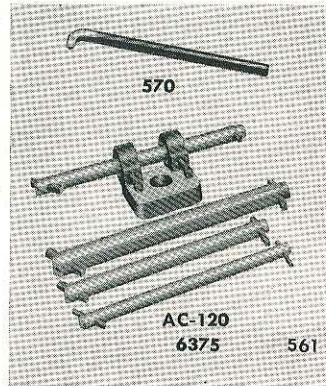

HEAVY DUTY BORING TOOL SETS

Mounts on compound and is held in place by regular tool post.

No. AC-120 Heavy Duty Boring Bar Tool Set for Logan 9", 10", 11" and 12" lathes. Includes 3/8", 1/2", 5/8" and 3/4" bars. Each bar holds a tool bit at each end, one mounted at 45°, the other at 90°. Tool bits and wrenches included. Also holds all sizes of No. 570 bars. Shipping weight, 8 lbs.

No. 6375 Heavy Duty Boring Bar Tool Set for Logan 14" lathe. Includes 3/8", 1/2", 5/8", 3/4", 1" and 1 1/4" bars with two bits on each bar. Complete set packed in wood box, 1 holder, 6 boring bars, tool bits and wrenches. Shipping weight, 23 lbs.

CUTTER BITS

No. 560 HSS Blank Cutter Bits, size 1/4" x 1/4"—packaged set of 6, ship. wt. 1 lb.

No. 561 HSS Formed Cutter Bits, size 1/4" x 1/4"—packaged set of 6, ship. wt. 1 lb.

No. 558 Carbide Tipped Formed Bits, size 1/4" x 1/4"—packaged set of 6, ship. wt. 1 lb.

No. 660 HSS Blank Cutter Bits, size 5/16" x 5/16". Packaged set of 6. Ship. wt. 1 lb.

CENTER COUNTERSINK DRILLS

Drill and countersink bearings for Lathe Center. Three sizes.

No.	Size	Ship. wt.
575-A	1/16"	1/4 lb.
575-B	3/32"	1/4 lb.
575-C	1/8"	1/4 lb.

60° MALE CENTER

No. LA-187 Hardened, ground. No. 2 M. T. shank. Ship. wt. 1/2 lb.

No. 6113 Hardened, ground. No. 3 M. T. Shank. Ship. wt. 1 lb.

LATHE DOGS

Bent Tail Type, with Square Head Set Screw.

No.	Cap.	Ship. wt.
580-A	3/8"	1/4 lb.
580-B	1/2"	1/4 lb.
580-C	3/4"	1/4 lb.
580-D	1"	1/2 lb.
580-E	1 1/4"	1/2 lb.
580-F	1 1/2"	1/2 lb.

Clamp Type

No.	Cap.	Ship. wt.
585	1 3/4"	1/2 lb.
586	2 1/4"	3/4 lb.

ANTI-FRICTION CENTER

Superior quality. Live center. Grease-sealed precision bearings. Centerpiece angle 60°.

No. 595 No. 2 Morse Taper Shank. Ship. Wt., 3 lbs.

No. 596 No. 3 Morse Taper Shank. Ship. Wt., 4 lbs.

DRILL PAD

No. AC-300 No. 2 Morse Taper. 2" Diameter. Ship. Wt., 1 lb.

LACQUER ENAMEL

No. 499 1 pt.—Matches Standard Logan Gray. Brush or Spray. Shipping wt., 2 lbs.

DRIVE AND FACE PLATES

Cat. No.	Description	Diam.	Spindle Size	Ship. Wt. Lbs.
LA-170	Drive Plate	6"	1 1/2"-8 thd.	4
LA-1009	Drive Plate	6"	2 1/4"-8 thd.	4
2307	Drive Plate	7"	L-00	10
LA-344	Face Plate	8"	1 1/2"-8 thd.	6
LA-1008	Face Plate	8"	2 1/4"-8 thd.	6
2010†	Face Plate	10"	2 1/4"-8 thd.	16
2310	Face Plate	10"	L-00	16
6383*	Face Plate	12"	2 1/4"-8 thd.	21

*Fits 14" lathes only.

†Fits 12" and 14" lathes only.

ADJUSTABLE MACHINE LIGHT

Bolts directly on machine, or slips into bracket mount. Double arm has three flexible joints. Takes 100-watt, A-21 lamp. Overall length, 37 1/2". 8' heavy duty cord and plug.

No. 500 Shipping weight, 4 lbs.



ACCESSORIES

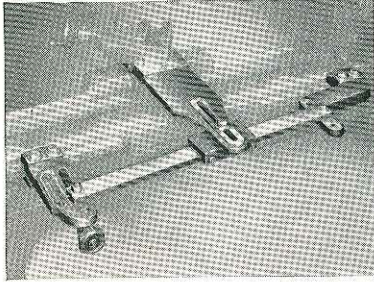

TAPER ATTACHMENTS

Exclusive "Micro-Screw" feature gives quick, positive adjustments of slide bar to desired taper. Easily installed, with taper attachment cross slide becoming a permanent part of the lathe. Quickly detached.

Cat. No.	Lathes	Maximum Taper Length At One Setting	Per Ft.	Angle 0°	Ship. Wt. Lbs.
AC-270	9"	12½"	4"	19°	15
AC-275	9B series	12½"	4"	19°	15
AC-298	10"	12½"	4"	19°	18
AC-295	11"	12½"	4"	19°	20
AC-2296†	12"	12½"	4"	19°	22
2350*†	12"	10"	4½"	20°	48
6330*	14"	10"	4½"	20°	60

*TELESCOPIC TAPER ATTACHMENT—Telescopic cross feed screw eliminates disengaging cross feed screw nut as is necessary with plain Taper Attachments.

†For current "2500" series 12" Lathes only.

MICA UNDERCUTTER

Mounts on the cross slide, leaving the tool post free to hold the trueing tool. The high speed saw is rigidly held to assure clean, even, parallel cuts and is adjustable for depth of cut desired. Saw stroke is 2 inches. Furnished with two saws, one .015" thick, the other .020" thick.

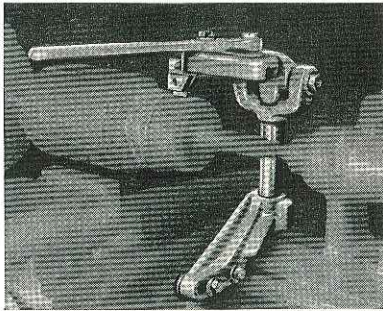

No. 490 For Logan 9", 10", 11" and 12" Lathes. Shipping weight, 8 lbs.

No. 488 Mica Undercutter Saws. Packet of 6 blades, .015". Ship. wt., ¼ lb.

No. 489 Mica Undercutter Saws. Packet of 6 blades, .020". Ship. wt., ¼ lb.

AUXILIARY HEAD

Adapts Logan 11" Lathes for Oversize Work

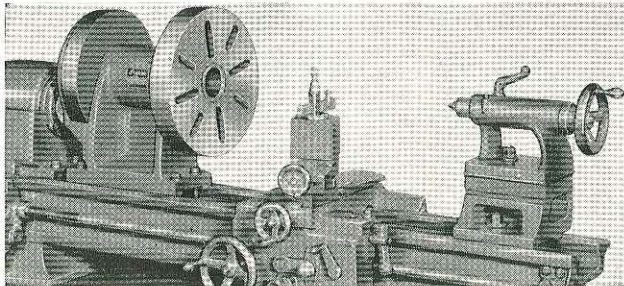

Mounted on Logan 11" Lathe. Note raising blocks in position under the tool post and tailstock

Gives Logan 11" Lathes 16" Swing over bed and 14½" Swing over saddle wings... Ball Bearing Mounted Spindle... 2¼", 8-Thread Spindle Nose... Attached in 10 minutes, easy to detach... 12" Face Plate.

Gear reduction feature permits cutting threads four times as coarse as in regular operation. Spindle center is set back as well as elevated. As a result, in turning large work, the pressure from the cut is over the lathe way, not overhanging. Provides the smooth operation on heavy cuts essential to accuracy. Raising blocks for the tool post and tailstock assembly furnished.

No. AC-400 Shipping weight, complete, 140 lbs.

CARRIAGE STOPS

No. AC-234 Micrometer Carriage Stop. Collar graduated in .001". Setting may be locked for duplicate work. For 9", 10", 11" and 12" Logan Lathes. Ship. wt., 3 lbs.

No. 6365 Micrometer Carriage Stop. Graduated in .001" with collar lock. For Logan 14" Lathes. Ship. wt., 5 lbs.

No. AC-226 Double Carriage Stop. Adjustable screws set carriage for two desired positions. Used either side of carriage. For 9", 10", 11" and 12" Logan Lathes. Ship. wt., 3 lbs.

No. AC-225 Carriage Stop. Used either side of carriage. Screw with lock-nut gives accurate adjustment. For 9", 10", 11" and 12" Logan Lathes. Ship. wt., 2 lbs.

MULTIPLE CARRIAGE STOP

Six positions. Mounts on lathe bed.

No. AC-435 For all 12" Lathes. Ship. wt., 5 lbs.

No. AC-437 For all Quick Change 11" Lathes. Ship. wt., 5 lbs.

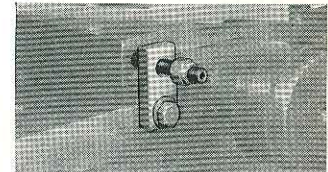
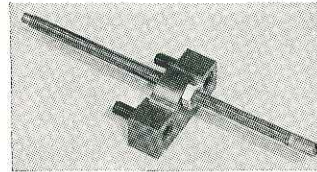

THREADING STOPS

No. AC-352 6" adjustable range. Mounts on rear of saddle on 9", 10" and 11" Logan Lathes. Adjustable screw for positive stop against cross feed nut. Template furnished. Shipping weight, 3 lbs.

No. 6380 For 12" and 14" Logan Lathes. Mounts on saddle with adjustable screw in compound base. Template furnished. Shipping weight, 3 lbs.

CENTER RESTS

The center rest (or steady rest) mounts on the lathe bed to support long thin work and prevent distortion. Three adjustable machined jaws.

Cat. No.	Capacity	Lathe Size	Ship. Wt.
AC-280	3"	1400	9 lbs.
AC-282	3"	9B series	9 lbs.
AC-189	3"	10"	10 lbs.
AC-290	3"	11"	10 lbs.
AC-2189	3"	12"	11 lbs.
6315	4¾"	14"	23 lbs.

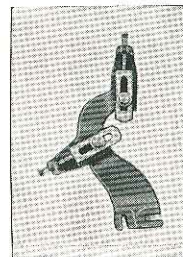
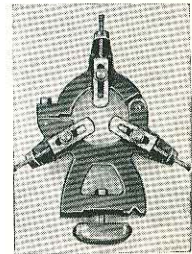

FOLLOWER RESTS

The follower rest mounted on the lathe carriage and travels with the carriage to support long thin work. Two adjustable machined jaws.

Cat. No.	Capacity	Lathe Size	Ship. Wt.
AC-285	3"	9"	4 lbs.
AC-196	3"	10", 11"	5 lbs.
AC-2196	3"	12"	6 lbs.
6320	4¼"	14"	9 lbs.

BAR FEED

For use on No. 1830 or No. 1830-2 Hand Screw Machines only. Maximum capacity ⅝" round stock. Maximum feed per stroke is 2". No. AC-50 Push Type Collets are used in sizes from ¼" to ⅝". A patented cam action prevents feeding while bar is being locked in collet and eliminates locking while bar is being fed.

No. LA-32-34 Ship. wt. 45 lbs.

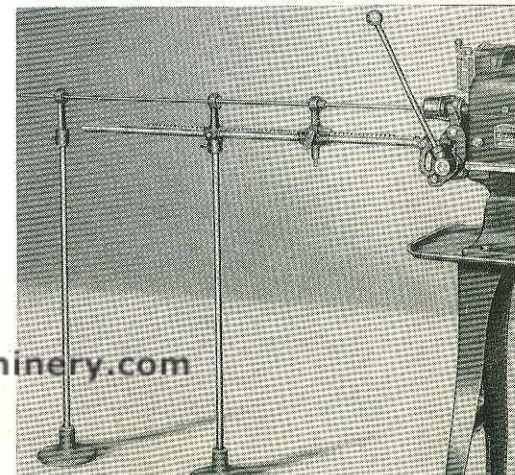

L A T H E A C C E S S O R I E S

1750 RPM ELECTRIC MOTORS

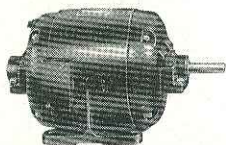

Stock motors listed below are manufactured by dependable sources and have drip proof open type frames. Single phase motors are capacitor type start-stop-reverse, and three phase motors are quick reversing. We definitely recommend three phase motors on motor sizes of 1 H.P. or larger and wherever possible on the smaller sizes. There will be a charge on a cost basis for mounting customers' motors on Logan machines. In addition to the stock motors listed, we can supply motors for special requirements on request.

Cat. No.	H. P.	R. P. M.	Phase	Voltage	Cycle	Bearings	Lathe Size	Ship. Wt.
1101	1/3	1750	1	110/220	60	Sleeve	9"	33 lbs.
1105	1/2	1750	1	110/220	60	Sleeve	10"	50 lbs.
1106	1/2	1750	1	110/220	50	Sleeve	10"	50 lbs.
1110	1/2	1750	3	220/440	60	Sleeve	10"	50 lbs.
1111	1/2	1750	3	220/380	60	Sleeve	10"	50 lbs.
1116-L	3/4	1750	1	110/220	60	Ball	11" Bench & Floor	65 lbs.
1116-C	3/4	1750	1	110/220	60	Ball	11" Cabinet	65 lbs.
1118-L	3/4	1750	3	220/440	60	Ball	11" Bench & Floor	60 lbs.
1118-C	3/4	1750	3	220/440	60	Ball	11" Cabinet	60 lbs.
1120	1	1750	3	220/440	60	Ball	12"	60 lbs.
1114	1	1800/900	3	220	60	Ball	12"	40 lbs.
1122	2	1750	3	220/440	60	Ball	14"	70 lbs.

MOTOR SWITCHES

No. 0388 HIGH-LOW SWITCH for 2-speed motor No. 1114. Used in addition to regular drum reversing switch furnished with lathe. Shipping weight 3 lbs.

No. AC-115 DRUM REVERSING SWITCH, Switch Box and 30" rubber covered cable. For 9" Lathes. Shipping weight, 5 lbs.

MOTOR CONTROLS

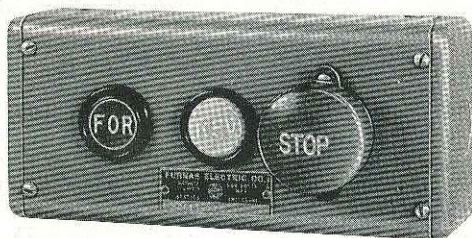

OPTIONAL ELECTRICAL EQUIPMENT

For all Logan Cabinet Model Lathes, or Shaper. Price includes complete installation and wiring. Be sure to specify voltage on which motor will be operated.

THERMAL OVERLOAD PROTECTION

Separate unit used between regular drum switch and motor. Automatically cuts out to prevent damage to motor from overheating due to overload.

No. 2325 Thermal Overload Switch.

OVERLOAD & UNDERVOLTAGE

Magnetic relay unit used in conjunction with regular reversing drum switch. Provides complete motor protection plus safety protection to machine and operator. Stops motor when voltage drops below safe level, or power is interrupted. Machine will not accidentally start up when power is resumed even though control switch has been left on.

No. 2330 Magnetic Overload & Undervoltage Switch.

REVERSING MAGNETIC STARTER

Complete motor protection as well as safety protection to machine and operator. Full motor load carried through starter only—control circuit carries only enough current to operate the magnets which open and close the contacts. Push button station has FORWARD-REVERSE-STOP. Large mushroom head stop button is extra sensitive and easily operated from a wide angle for quick stops.

No. 6350 Reversing Magnetic Starter.

For additional protection to operator (required by code in some localities) above unit is available with reduced voltage to push buttons.

No. 6350T Reversing Magnetic Starter with Control Transformer.

Note: Power lines should be properly fused when used with all of above devices to prevent damage from short circuits. Fuse rating should be at least 3 times and not over 4 times motor ampere rating.

J. I. C. CONTROLS

Magnetic Starters (fused or unfused) of light pushbutton controls, and totally enclosed motors to J.I.C. specifications. Ask for quotation to fit your exact requirements.

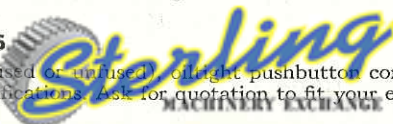

www.SterlingMachinery.com

S H A P E R A C C E S S O R I E S

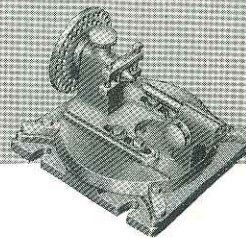

INDEX CENTERS

No. 8-199 5 inches between centers. 3-inch swing. Index plate with divisions between 22-30. Shipping wt., 16 lbs.

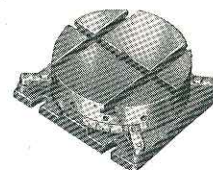

ROTARY TABLE

No. 8-249 7" diameter work surface with 3 "T" slots. Shipping wt., 23 lbs.

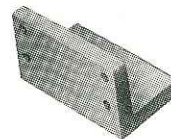

ANGLE PLATE

No. 8-275 For clamping irregular work to table. Size, 3" x 3" x 5". Ship. wt., 7 lbs.

SHAPER TOOL HOLDER



No. 540 Standard Tool Holder. Ship. wt., 1 lb.

SHAPER EXTENSION TOOL HOLDER

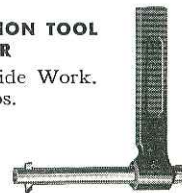

No. 541 For Inside Work. Ship. wt., 1 1/2 lbs.



KEYWAY TOOL HOLDERS

No. 8-280 7/16" for Cutting Keyways and Slotting on Inside Work. Ship. wt. 1 lb.

No. 8-281 5/8" for Cutting Keyways and Slotting on Inside Work. Ship. wt., 1 lb.

BLANK CUTTER BITS

No. 560 Set of 6. Unground, measure 1/4 x 1/4 x 2". Heat treated high speed steel. Shipping wt., 1 lb.

"T" HEAD BOLTS

No.	Size	Ship. wt.
8-258	1"	1/2 lb.
8-260	2 1/4"	3/4 lb.
8-261	3 1/4"	1 lb.

Logan

8" SHAPER

Combines capacity, precision and versatility. Powerful $8\frac{1}{2}$ " maximum stroke permits full and accurate machining of work 8" long. Handles straight cuts, angular cuts, squaring, machining and slotting. Six automatic feeds in either direction, from .002" to .012" are set by a feed dial graduated to .001". A half turn of the feed handle in either direction reverses the feed. Any speed from 35 to 180 strokes per minute is quickly obtainable. Speed changes are effected instantly, by simply turning the hand wheel control. No need to stop motor or shift belt.

Table, 8" wide by 8" long, has a vertical travel of $5\frac{1}{2}$ " and a $10\frac{1}{2}$ " traverse. The adjustable table support mounted on the base of the machine, provides solid reinforcement.

Because the tool head may be swiveled 360° , squaring the ends of stock of almost any length is possible on the Logan Shaper. The stock is laid horizontally and the head turned to present the tool in proper position. Tool head vertical travel is $2\frac{3}{8}$ ".

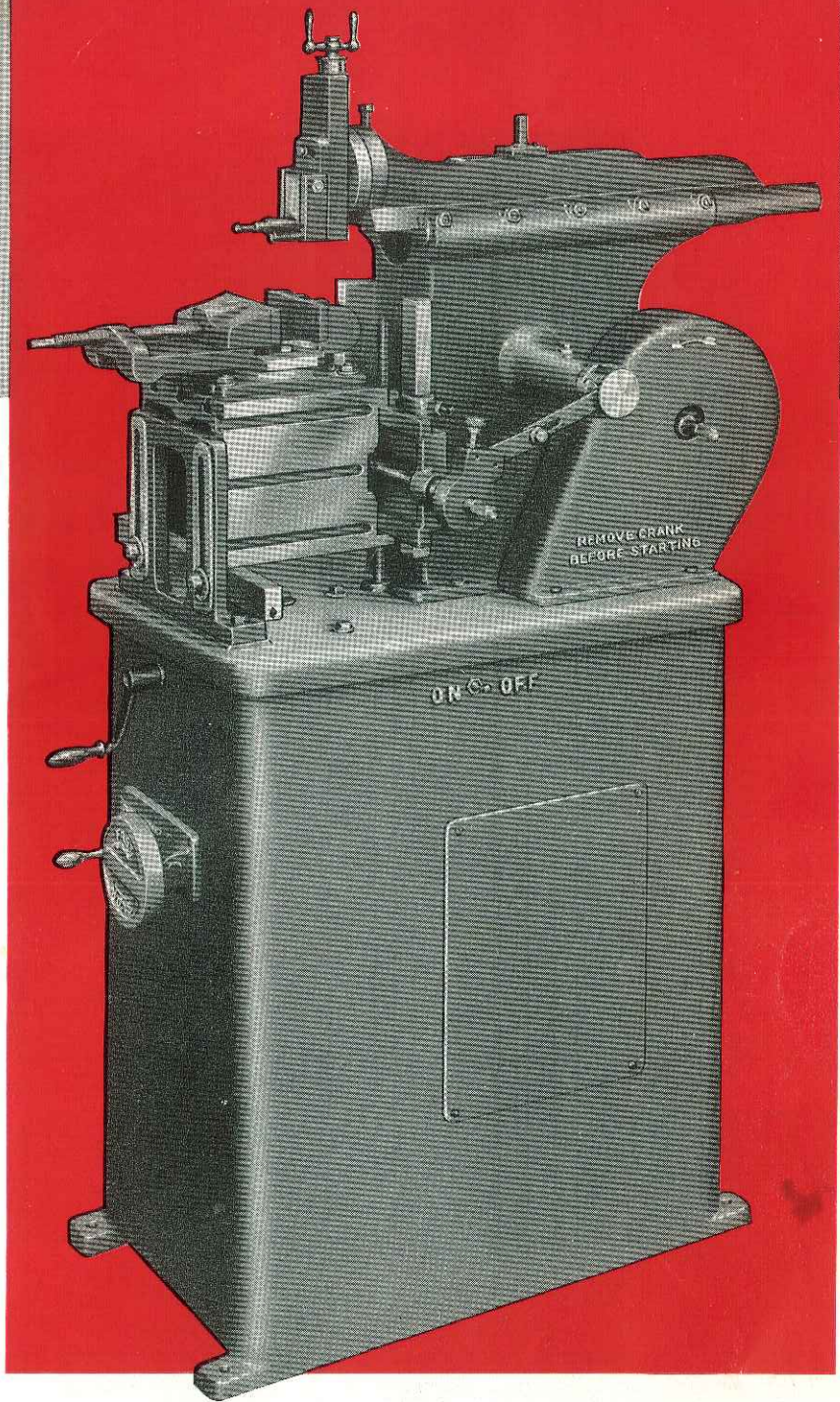

LOGAN 8-INCH SHAPERS

No. ES8-5 $\frac{1}{2}$	With $\frac{1}{2}$ H.P., 1 Phase, 110/220V, 60-Cycle Motor. Shipping weight, 690 lbs.
No. ES8-T $\frac{1}{2}$	With $\frac{1}{2}$ H.P., 3 Phase, 220/440V, 60-Cycle Motor. Shipping weight, 690 lbs.
No. ES8-5 $\frac{3}{4}$	With $\frac{3}{4}$ H.P., 1 Phase, 110/220V, 60-Cycle Motor. Shipping weight, 700 lbs.
No. ES8-T $\frac{3}{4}$	With $\frac{3}{4}$ H.P., 3 Phase, 220/440V, 60-Cycle Motor. Shipping weight, 700 lbs.
No. ES8	Shaper, Less Motor. Shipping weight, 640 lbs.

SPECIFICATIONS

Length of ram, 19" . . . width of ram, $5\frac{3}{16}$ " . . . width of ram ways, $5\frac{3}{16}$ " . . . Cross-rail ways, $\frac{5}{8}$ " x $\frac{3}{4}$ " x $5\frac{1}{4}$ " . . . length of stroke, $8\frac{1}{2}$ " . . . length of ram bearings, 19" . . . bearing surface of ram, 51 sq. in. . . vertical travel of tool head, $2\frac{3}{8}$ " . . . size of tool holder, $\frac{7}{16}$ " x $\frac{7}{8}$ " . . . tool head swivel, 360° . . . tool head diameter, 4" . . . length of cross rail, $13\frac{7}{8}$ " . . . horizontal travel of table, $10\frac{1}{2}$ " . . . vertical travel of table, $5\frac{1}{2}$ " . . . distance, top of table to ram (maximum), 8" . . . working surface of table, 8" x 8" . . . slots in table (3 on top and 3 on side), $\frac{7}{16}$ " . . . table depth, $7\frac{1}{2}$ " . . . saddle bearing, $5\frac{1}{4}$ " . . . feeds, .002, .004, .006, .008, .010, and .012" . . . speeds, "Any-speed," 35 to 180 strokes per minute . . . size of motor, $\frac{1}{2}$ h.p. or $\frac{3}{4}$ h.p. . . . cutting speeds, up to 120 feet per minute . . . vise, swivel 300° , $5\frac{1}{4}$ " opening, 5" width . . . weight with motor, 700 lbs. . . overall dimensions, 15" wide, 35" deep, 51" high.

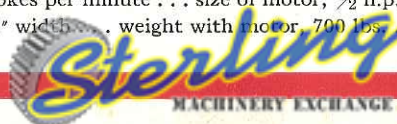

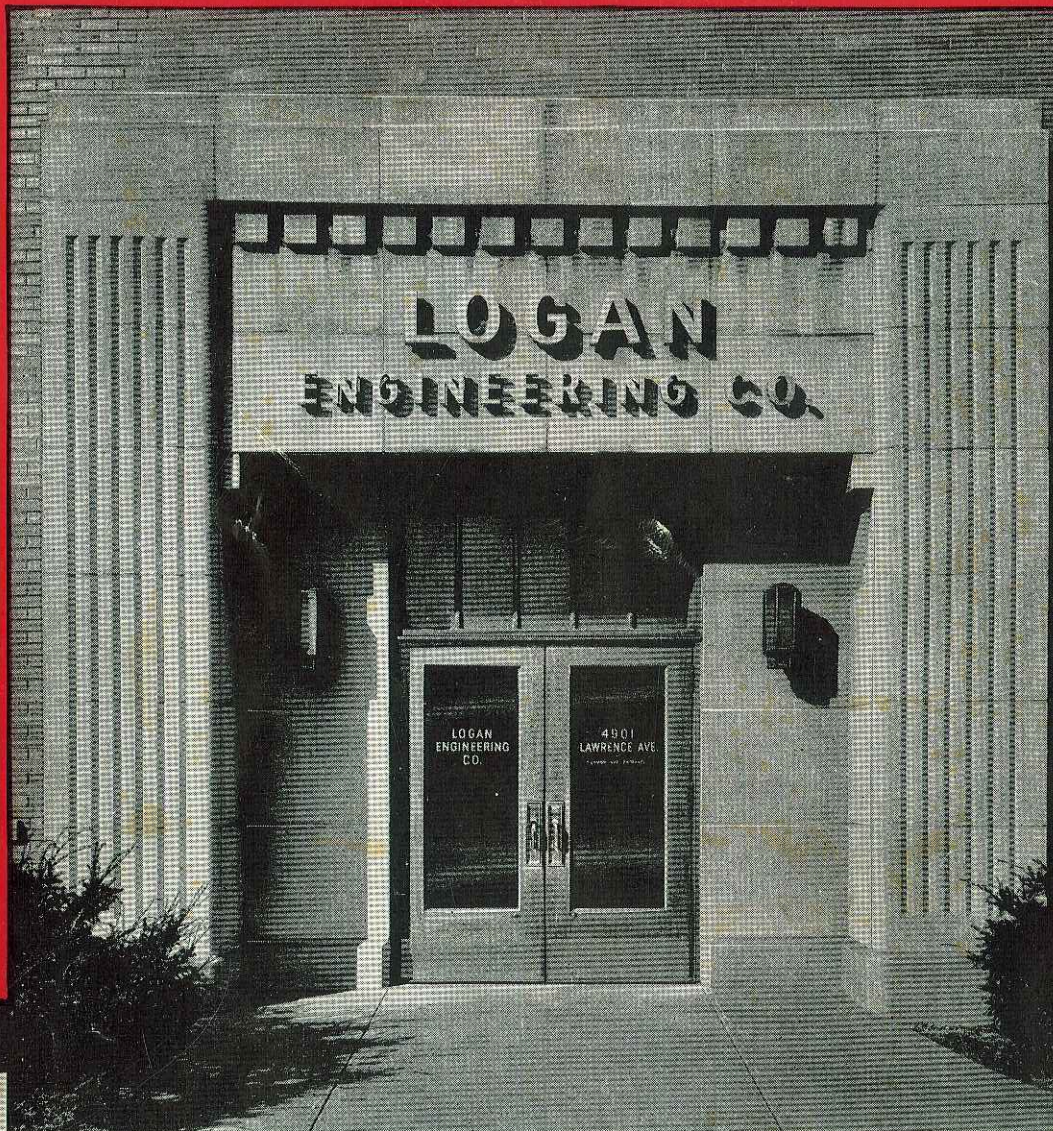

The proving ground for Logan Lathes has been in the factories and shops of American industry. Over a period of years the record made by Logan Lathes on the job has earned widespread acceptance and high regard for Logan products. Pride in these results, made possible by the coordinated effort of the entire Logan organization, is only natural. A continuing program of improvement in equipment, methods and design is under way to maintain the leading position of Logan products in their respective fields.

LOGAN ENGINEERING CO. CHICAGO 30, ILLINOIS

LOOK TO

Logan

FOR *BETTER* LATHES AND SHAPERS

Catalog LS-57-21857-10M

Printed in U.S.A.

Sterling
MACHINERY EXCHANGE

www.SterlingMachinery.com